



**MODEL:**

# **DRPC-124-EHL Series**

**Fanless embedded system with Intel® Celeron® J6412 2.0GHz (up to 2.6 GHz, Quad Core, TDP 10W), on board 8GB LPDDR4x memory, 4 x USB, 1 x HDMI, 4 x GbE LAN, 12-28V DC, RoHS**

## **User Manual**

# Revision

---

Date	Version	Changes
July 28, 2023	1.00	Initial release
June 11,2024	1.01	1. Supplementary COM1-2 422/485 Connector Pinouts 2. Serial cable Partner Number

# Copyright

---

## **COPYRIGHT NOTICE**

The information in this document is subject to change without prior notice in order to improve reliability, design and function and does not represent a commitment on the part of the manufacturer.

In no event will the manufacturer be liable for direct, indirect, special, incidental, or consequential damages arising out of the use or inability to use the product or documentation, even if advised of the possibility of such damages.

This document contains proprietary information protected by copyright. All rights are reserved. No part of this manual may be reproduced by any mechanical, electronic, or other means in any form without prior written permission of the manufacturer.

## **TRADEMARKS**

All registered trademarks and product names mentioned herein are used for identification purposes only and may be trademarks and/or registered trademarks of their respective owners.

# Manual Conventions

---



## **WARNING**

Warnings appear where overlooked details may cause damage to the equipment or result in personal injury. Warnings should be taken seriously.



## **CAUTION**

Cautionary messages should be heeded to help reduce the chance of losing data or damaging the product.



## **NOTE**

These messages inform the reader of essential but non-critical information. These messages should be read carefully as any directions or instructions contained therein can help avoid making mistakes.



## **HOT SURFACE**

This symbol indicates a hot surface that should not be touched without taking care.

# Table of Content

<b>1 INTRODUCTION.....</b>	<b>1</b>
1.1 OVERVIEW.....	2
1.2 FEATURES.....	2
1.3 TECHNICAL SPECIFICATIONS .....	3
1.4 FRONT PANEL.....	4
1.5 PHYSICAL DIMENSIONS .....	5
<b>2 UNPACKING .....</b>	<b>6</b>
2.1 ANTI-STATIC PRECAUTIONS .....	7
2.2 UNPACKING PRECAUTIONS.....	7
2.3 UNPACKING CHECKLIST .....	8
<b>3 INSTALLATION .....</b>	<b>10</b>
3.1 INSTALLATION PRECAUTIONS .....	11
3.2 BACK COVER REMOVAL.....	12
3.3 STORAGE INSTALLATION .....	13
3.4 IO EXTENSION INSTALLATION (OPTIONAL).....	13
3.5 BACK COVER INSTALLATION.....	15
3.6 MOUNTING THE SYSTEM.....	15
3.6.1 <i>DIN-Rail Installation</i> .....	15
3.6.2 <i>Wall Mounting Installation</i> .....	16
3.7 EXTERNAL PERIPHERAL INTERFACE CONNECTORS.....	17
3.7.1 <i>HDMI Connector</i> .....	17
3.7.2 <i>LAN Connectors</i> .....	18
3.7.3 <i>Power Connector</i> .....	19
3.7.4 <i>USB Connectors</i> .....	20
3.8 POWERING ON/OFF THE SYSTEM .....	21
3.9 AVAILABLE DRIVERS .....	22
3.9.1 <i>Driver Download</i> .....	22
<b>4 SYSTEM MOTHERBOARD .....</b>	<b>24</b>

4.1 OVERVIEW.....	25
4.2 LAYOUT.....	25
4.3 PERIPHERAL INTERFACE CONNECTORS.....	26
4.4 CLEAR CMOS BUTTON CONNECTOR.....	27
4.5 AT/ATX POWER MODE SETTING.....	28
4.6 DNX MODE SETTING JUMPER.....	29
4.7 FLASH DESCRIPTOR OVERRIDE SETTING JUMPER .....	30
4.8 RTC BATTERY CONNECTOR .....	31
4.9 BUZZER CONNECTOR .....	32
4.10 RS-232/422/485 SERIAL PORT CONNECTOR .....	34
4.11 MINI SATA CONNECTOR .....	36
4.12 FLASH SPI ROM CONNECTOR .....	37
4.13 FLASH EC ROM CONNECTOR .....	38
4.14 I <sup>2</sup> C CONNECTOR.....	39
4.15 HDMI DEBUG CONNECTOR .....	40
4.16 INTERNAL USB 2.0 CONNECTORS .....	41
4.17 DIGITAL INPUT / OUTPUT CONNECTOR.....	41
4.18 FRONT PANEL CONNECTOR .....	42
4.19 M.2 B-KEY SLOT (B1).....	44
4.20 M.2 B-KEY SLOT (B2).....	46
4.21 M.2 M-KEY SLOT.....	47
<b>5 BIOS.....</b>	<b>50</b>
5.1 INTRODUCTION.....	51
5.1.1 Starting Setup.....	51
5.1.2 Using Setup .....	52
5.1.2.1 Keyboard Navigation .....	52
5.1.2.2 Touch Navigation .....	53
5.1.3 Getting Help.....	54
5.1.4 Unable to Reboot after Configuration Changes .....	54
5.1.5 BIOS Menu Bar.....	54
5.2 MAIN.....	55
5.3 ADVANCED.....	58
5.3.1 CPU Configuration .....	59
5.3.2 Trusted Computing.....	63

## DRPC-124-EHL

5.3.3 <i>IT5571 Super IO Configuration</i> .....	64
5.3.3.1 <i>Serial Port 1 Configuration</i> .....	64
5.3.3.2 <i>Serial Port 2 Configuration</i> .....	66
5.3.4 <i>IT5571 H/W Monitor</i> .....	67
5.3.5 <i>Serial Port Console Redirection</i> .....	67
5.3.5.1 <i>Console Redirection Settings</i> .....	68
5.3.6 <i>NVMe Configuration</i> .....	71
5.4 <b>CHIPSET</b> .....	71
5.4.1 <i>System Agent (SA) Configuration</i> .....	72
5.4.1.1 <i>Memory Configuration</i> .....	74
5.4.1.2 <i>Graphics Configuration</i> .....	75
5.4.2 <i>PCH-IO Configuration</i> .....	77
5.4.2.1 <i>PCI Express Configuration</i> .....	80
5.4.2.1.1 <i>PCI Express Root Port Setting</i> .....	81
5.4.2.2 <i>SATA Configuration</i> .....	83
5.4.2.3 <i>HD Audio Configuration</i> .....	84
5.5 <b>SECURITY</b> .....	85
5.6 <b>BOOT</b> .....	86
5.6.1 <i>Boot Configuration</i> .....	86
5.6.2 <i>Boot Option Priorities</i> .....	87
5.7 <b>SAVE &amp; EXIT</b> .....	88

# List of Figures

---

Figure 1-1: DRPC-124-EHL Series.....	2
Figure 1-2: Front Panel .....	4
Figure 1-3: Physical Dimensions .....	5
Figure 3-1: Remove the Cover .....	12
Figure 3-2: Inserting the M.2 Module into the Slot at an Angle.....	13
Figure 3-3: Securing the M.2 Module.....	13
Figure 3-4: RS-232 Cable Installation .....	14
Figure 3-5: RS-232 DB9 Cable Installation .....	14
Figure 3-6: Back Cover Installation .....	15
Figure 3-7: DIN Rail Mounting Bracket Installation .....	16
Figure 3-8: Mounting Bracket Retention Screw .....	17
Figure 3-9: HDMI Connection .....	18
Figure 3-10: LAN Connection .....	18
Figure 3-11: RJ-45 Ethernet Connector .....	19
Figure 3-12: Power Connector .....	20
Figure 3-13: USB Connection.....	20
Figure 3-14: Power Input.....	21
Figure 4-1: Connector and Jumper Locations.....	25
Figure 4-2: Clear CMOS Location .....	27
Figure 4-3: AT/ATX Power Mode Switch Locations .....	28
Figure 4-4: DNX Mode Setting Jumper Location .....	29
Figure 4-5: Flash Descriptor Override Setting Jumper Locations .....	30
Figure 4-6: Battery Connector Location.....	32
Figure 4-7: Buzzer Connector Location .....	33
Figure 4-8: RS-232/422/485 Serial Port Connector Location.....	34
Figure 4-9: Mini SATA Connectors Location .....	36
Figure 4-10: Flash SPI ROM Connector Location .....	37
Figure 4-11: Flash EC ROM Connector Location .....	38
Figure 4-12: I <sup>2</sup> C Connector Location .....	39
Figure 4-13: HDMI Debug Connector Location.....	40



## DRPC-124-EHL

Figure 4-14: Internal USB 2.0 Connectors Locations .....	41
Figure 4-15: Digital I/O Connector Location .....	42
Figure 4-16: Front panel Connector Location .....	43
Figure 4-17: M.2 B-key Slot Location.....	44
Figure 4-18: M.2 B-key Slot Location.....	46
Figure 4-19: M.2 M-key Slot Location .....	48
Figure 5-1: BIOS Starting Menu .....	51
Figure 5-2: BIOS Navigation Keys .....	52
Figure 5-3: BIOS On-screen Navigation Keys .....	53
Figure 5-4: BIOS Options and Configured USB Ports .....	79

# List of Tables

---

Table 1-1: Technical Specifications.....	4
Table 3-1: LAN4 GbE RJ-45 Ethernet Connector LEDs .....	19
Table 3-2: LAN1-3 2.5GbE RJ-45 Ethernet Connector LEDs.....	19
Table 3-3: Power Connector Pinouts.....	19
Table 4-1: Peripheral Interface Connectors .....	26
Table 4-2: Clear CMOS Pinouts.....	27
Table 4-3: AT/ATX Power Mode Switch Pinouts.....	28
Table 4-4: DNX Mode setting Jumper Pinouts.....	29
Table 4-5: Flash Descriptor Override Setting Jumper Pinouts.....	30
Table 4-6: Battery Connector Pinouts .....	32
Table 4-7: Buzzer Connector Pinouts.....	33
Table 4-8: RS-232/422/485 (COM1-2) Connector Pinouts .....	34
Table 4-9: SATA 6Gb/s Drive Connectors Pinouts.....	37
Table 4-10: Flash SPI ROM Connector Pinouts .....	38
Table 4-11: Flash EC ROM Connector Pinouts.....	39
Table 4-12: I <sup>2</sup> C Connector Pinouts.....	40
Table 4-13: HDMI Debug Connector Pinouts .....	40
Table 4-14: Internal USB 2.0 Connectors Pinouts.....	41
Table 4-15: Digital I/O Connector Pinouts.....	42
Table 4-16: Front panel Connector Pinouts.....	43
Table 4-17: M.2 B-Key Slot Pinouts .....	45
Table 4-18: M.2 B-Key Slot Pinouts .....	47
Table 4-19: M.2 B-key Slot Pinouts .....	49

# BIOS Menus

BIOS Menu 1: Main (1/2).....	55
BIOS Menu 2: Main (2/2).....	55
BIOS Menu 3: Advanced .....	58
BIOS Menu 4: CPU Configuration (1/3).....	59
BIOS Menu 5: CPU Configuration (2/3).....	59
BIOS Menu 6: CPU Configuration (3/3).....	60
BIOS Menu 7: Trusted Computing .....	63
BIOS Menu 8: IT5571 Super IO Configuration .....	64
BIOS Menu 9: Serial Port 1 Configuration Menu .....	64
BIOS Menu 10: Serial Port 2 Configuration Menu .....	66
BIOS Menu 11: IT5571 H/W Monitor.....	67
BIOS Menu 12:Serial Port Console Redirection .....	68
BIOS Menu 13: COM Console Redirection Settings .....	69
BIOS Menu 14: NVMe configuration .....	71
BIOS Menu 15: Chipset .....	72
BIOS Menu 16: System Agent (SA) Configuration .....	72
BIOS Menu 17: Memory Configuration.....	74
BIOS Menu 18: Graphics Configuration .....	75
BIOS Menu 19: PCH-IO Configuration (1/2) .....	77
BIOS Menu 20: PCH-IO Configuration (2/2) .....	77
BIOS Menu 21: PCI Express Configuration .....	80
BIOS Menu 22: PCIe Slot Configuration Submenu .....	81
BIOS Menu 23: SATA Configuration .....	83
BIOS Menu 24: HD Audio Configuration .....	84
BIOS Menu 25: Security .....	85
BIOS Menu 26: Boot .....	86
BIOS Menu 27: Save & Exit.....	88



Chapter

1

# Introduction

---

## 1.1 Overview



**Figure 1-1: DRPC-124-EHL Series**

The DRPC-124-EHL series embedded system adopts Intel® Elkhart Lake processor with onboard 8GB LPDDR4x memory (up to 16GB), and including one HDMI, four GbE LAN ports, four USB ports, one RS-232 /422/485 (optional).

## 1.2 Features

The DRPC-124-EHL Series features are listed below:

- Intel® Celeron® J6412 2.0GHz (up to 2.6GHz, quad-core, TDP 10W)
- Onboard 8GB LPDDR4x memory (up to 16GB)
- Four USB
- 4 x GbE ports
- 2 x M.2 B Key
- 1 x M.2 M Key

## DRPC-124-EHL

### 1.3 Technical Specifications

The DRPC-124-EHL Series technical specifications are listed in (Table 1-1).

		DRPC-124-EHL
Chassis	Color	Black
	Dimension( WxDxH)(mm)	159 x 132.5 x 35
	System Fan	Fanless
	Chassis Construction	Extruded aluminum alloy
Processor	CPU	Intel® Celeron® J6412 2.0GHz (up to 2.6GHz, quad-core, TDP 10W)
	Chipset	SoC
Memory	System Memory	Onboard LPDDR4x 3200MHz 8GB (up to 16GB)
Storage	SATA	eMMC 5.1 64GB/128GB (Optional)
I/O Interfaces	USB	2 x USB 3.2 Gen2 2 x USB 2.0
	Ethernet	1 x RJ-45 PCIe GbE by I210 controller 3 x RJ-45 PCIe 2.5 GbE by I225V controller
	Display	1 x HDMI 1.4b (up to 4k@ 30Hz)
	COM	1x RS-232/422/485 (DB9) (Optional)
	TPM2.0	Intel PTT
	Other	1 x Power Button (with LED), 1 x Clear BIOS Button
Expansions	M.2	1 x 2242 B-key (PCIe Gen3 x2) 1 x 2242 B-key (SATA) 1 x 2280 M-key (PCIe Gen3 x2)
Power	Power Input	DC jack: 12V-28 DC
	Power Consumption	12V@3.05 (Intel® Celeron® J6412 with 8GB DDR4 Memory)
Reliability	Mounting	DIN-Rail, Wall Mount
	Operating Temperature	-10 ~ 50°C with air flow (M.2), 10% ~ 95%, non-condensing
	Storage Temperature	-20°C ~70°C with air flow (M.2), 10% ~ 90%, non-condensing
	Operating Shock	Half-sine wave shock 5G, 11ms, 100 shocks per axis (M.2)
	Operation Vibration	MIL-STD-810G 514.6C-1 (M.2)
	Weight (Net/Gross)	0.7kg /1.2kg

	Safety / EMC	CE, FCC, UKCA
	Watchdog timer	Programmable 1~255 sec/min
OS	Supported OS	Microsoft® Windows® 10/11, Linux

**Table 1-1: Technical Specifications**

## 1.4 Front Panel

The front panel of the DRPC-124-EHL Series has the following features.

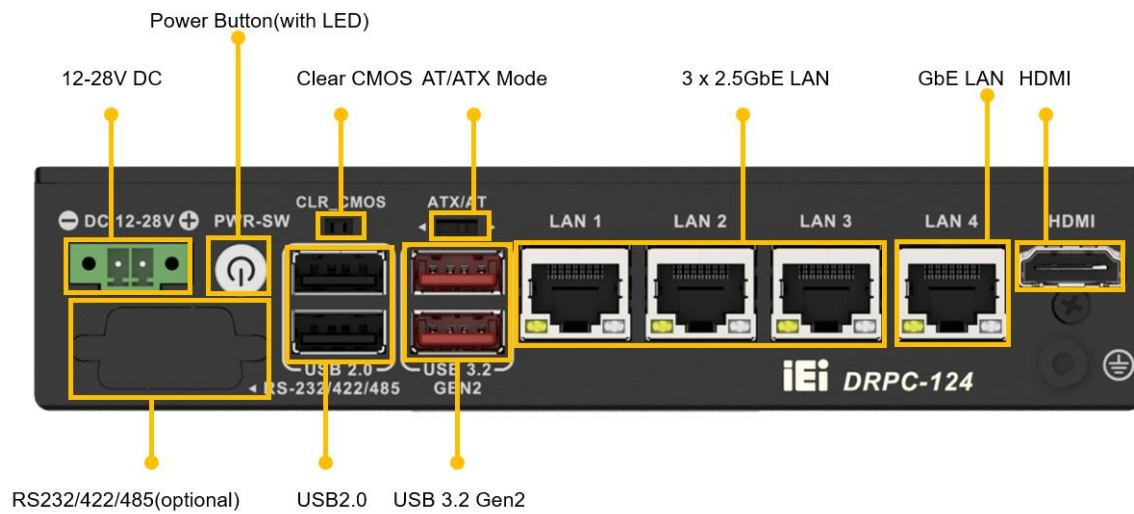

**Figure 1-2: Front Panel**



**DRPC-124-EHL**

**1.5 Physical Dimensions**

The physical dimensions of the DRPC-124-EHL Series are shown in (Figure 1-3).

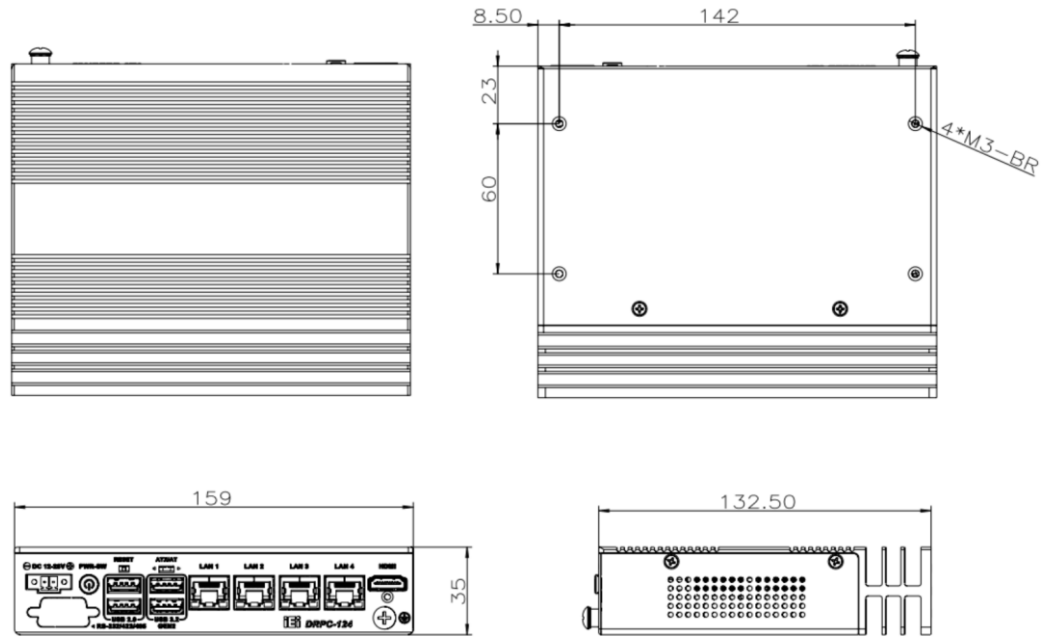

**Figure 1-3: Physical Dimensions**

Chapter

**2**

# Unpacking

---

## DRPC-124-EHL

## 2.1 Anti-static Precautions

---

**WARNING:**

Failure to take ESD precautions during installation may result in permanent damage to the DRPC-124-EHL Series and severe injury to the user.

---

Electrostatic discharge (ESD) can cause serious damage to electronic components, including the DRPC-124-EHL Series. Dry climates are especially susceptible to ESD. It is therefore critical that whenever the DRPC-124-EHL Series or any other electrical component is handled, the following anti-static precautions are strictly adhered to.

- **Wear an anti-static wristband:** Wearing a simple anti-static wristband can help to prevent ESD from damaging the board.
- **Self-grounding:** Before handling the board touch any grounded conducting material. During the time the board is handled, frequently touch any conducting materials that are connected to the ground.
- **Use an anti-static pad:** When configuring the DRPC-124-EHL Series, place it on an anti-static pad. This reduces the possibility of ESD damaging the DRPC-124-EHL Series.

## 2.2 Unpacking Precautions

When the DRPC-124-EHL Series is unpacked, please do the following:



- Follow the anti-static precautions outlined in **Section 2.1**.
- Make sure the packing box is facing upwards that the DRPC-124-EHL Series does not fall out of the box.
- Make sure all the components shown in **Section 2.2** are present.

## 2.3 Unpacking Checklist

 **NOTE:**

If some of the components listed in the checklist below are missing, please do not proceed with the installation. Contact the IEI reseller or vendor you purchased the DRPC-124-EHL Series from or contact an IEI sales representative directly. To contact an IEI sales representative, please send an email to [sales@ieiworld.com](mailto:sales@ieiworld.com).

The DRPC-124-EHL Series is shipped with the following components:

Quantity	Item and Part Number	Image
<b>Standard</b>		
1	DRPC-124-EHL Series	
2	DIN-Rail mounting kit	
1	Chassis screws	

**DRPC-124-EHL**

The following table lists the optional items that can be purchased separately.

<b>Optional</b>	
Power Adapter (P/N: 63040-430084-000-RS)	
Serial cable (P/N: 32205-005401-100-RS)	
DC Power Cord (P/N: 32102-045700-100-RS)	
Wall mounting kit (P/N: 41020-0522C2-00-HF*2)	
AC Power Cord (P/N: 32702-000202-100-RS)	

Chapter

**3**

# Installation

---

### 3.1 Installation Precautions

---

**CAUTION:**

The DRPC-124-EHL Series has more than one power supply connection point.

To reduce the risk of electric shock, disconnect all power sources before installing or servicing the DRPC-124-EHL Series.

---

During installation, be aware of the precautions below:

- **Read the user manual:** The user manual provides a complete description of the DRPC-124-EHL Series, installation instructions and configuration options.
- **DANGER! Disconnect Power:** Power to the DRPC-124-EHL Series must be disconnected during the installation process, or before any attempt is made to access the rear panel. Electric shock and personal injury might occur if the rear panel of the DRPC-124-EHL Series is opened while the power cord is still connected to an electrical outlet.
- **Qualified Personnel:** The DRPC-124-EHL Series must be installed and operated only by trained and qualified personnel. Maintenance, upgrades, or repairs may only be carried out by qualified personnel who are familiar with the associated dangers.
- **Air Circulation:** Make sure there is sufficient air circulation when installing the DRPC-124-EHL Series. The DRPC-124-EHL Series' cooling vents must not be obstructed by any objects. Blocking the vents can cause overheating of the DRPC-124-EHL Series. Leave at least 5 cm of clearance around the DRPC-124-EHL Series to prevent overheating.
- **Grounding:** The DRPC-124-EHL Series should be properly grounded. The voltage feeds must not be overloaded. Adjust the cabling and provide external overcharge protection per the electrical values indicated on the label attached to the back of the DRPC-124-EHL Series.

### 3.2 Back Cover Removal

Before installing or maintaining the internal components, the back cover must be removed from the DRPC-124-EHL. Follow the steps below to complete the task.

**Step 1:** Loosen the 7 screws on the top cover.

**Step 2:** Take off the back cover (Figure 3-1).



**Figure 3-1: Remove the Cover**



## DRPC-124-EHL

### 3.3 Storage Installation

The **DRPC-124-EHL** supports three types of M.2 storage to install an M.2 module, please follow the steps below.

**Step 1:** Locate the M.2 module slot. See Section 4.19

**Step 2:** Remove the retention screw secured on the motherboard.

**Step 3:** Line up the notch on the module with the notch on the slot. Slide the M.2 module into the socket at an angle of about 20° (Figure 3-2).

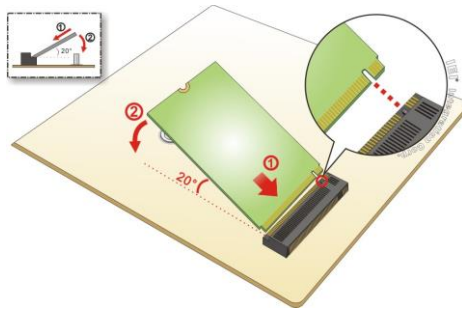

**Figure 3-2: Inserting the M.2 Module into the Slot at an Angle**

**Step 4:** Secure the M.2 module with the previously removed retention screw (Figure 3-3).

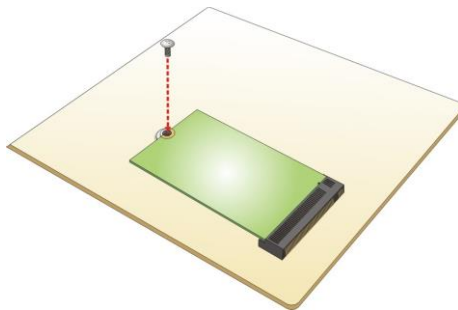

**Figure 3-3: Securing the M.2 Module**

### 3.4 IO extension Installation (Optional)

**DRPC-124-EHL** series products have reserved serial port expansion capabilities, and provide optional wire. To install, follow the steps below.

**Step 1:** Locate the Serial port connector. See Section 4.10

**Step 2:** Connect the serial cable to the serial connector on the mainboard. (Figure 3-4)

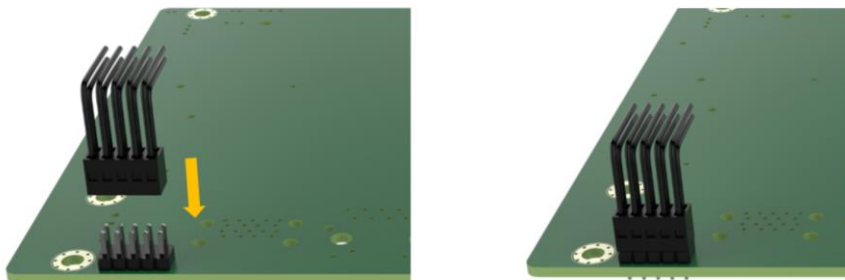

**Figure 3-4: RS-232 Cable Installation**

**Step 3:** Knock out the reserved holes on the chassis and Secure the DB9 end of the serial cable to the panel. (Figure 3-5)

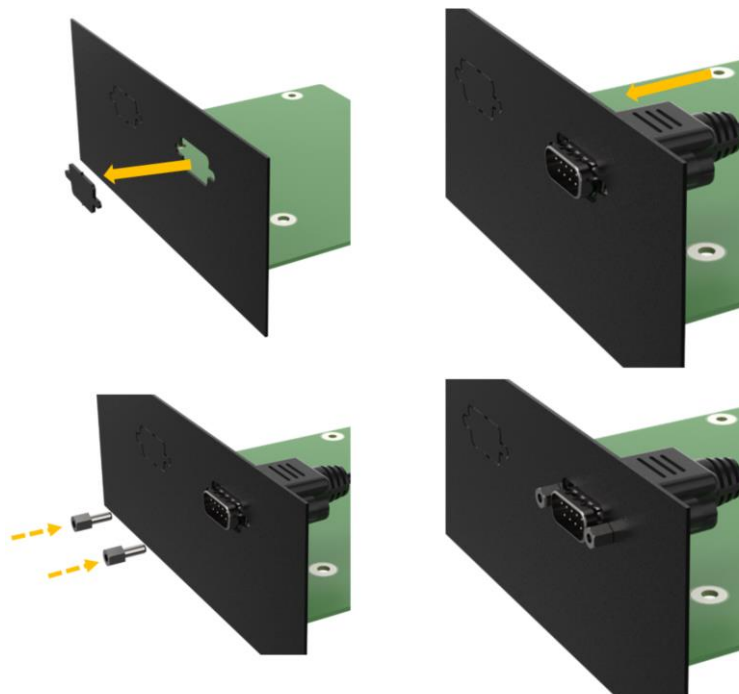

**Figure 3-5: RS-232 DB9 Cable Installation**

## DRPC-124-EHL

### 3.5 Back Cover Installation

Install the back cover, and fasten the 7 screws on the side. (Figure 3-6)



Figure 3-6: Back Cover Installation

### 3.6 Mounting The System

DRPC-124-EHL comes with standard rail mounting bracket and optional wall mounting bracket. Follow these steps to install.

#### 3.6.1 DIN-Rail Installation

**Step 1:** Turn the embedded system over.

**Step 2:** Align the retention screw holes in each bracket with the corresponding retention screw holes on the rear surface.

**Step 3:** Secure the brackets to the system by inserting retention screws (Figure 3-7)



**Figure 3-7: DIN Rail Mounting Bracket Installation**

### **3.6.2 Wall Mounting Installation**

**Step 1:** Turn the embedded system over.

## DRPC-124-EHL

**Step 2:** Align the retention screw holes in each bracket with the corresponding retention screw holes on the bottom surface.

**Step 3:** Secure the brackets to the system by inserting retention screws into each bracket (Figure 3-8)



**Figure 3-8: Mounting Bracket Retention Screw**

### 3.7 External Peripheral Interface Connectors

The DRPC-124-EHL Series has the following connectors. Detailed descriptions of the connectors can be found in the subsections below.

- Ethernet
- Power button
- Power DC jack
- HDMI
- USB

#### 3.7.1 HDMI Connector

To connect the HDMI devices, please plug in HDMI connector in the right direction as shown below:

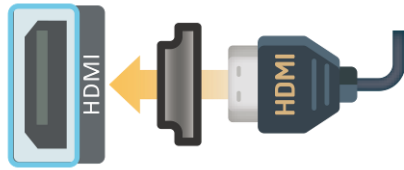

**Figure 3-9: HDMI Connection**

### 3.7.2 LAN Connectors

The LAN connectors allow connection to an external network

**Step 1: Locate the RJ-45 connectors.** The locations of the RJ-45 connectors are shown in **Chapter 1**

**Step 2:** Align the connectors. Align the RJ-45 connector on the LAN cable with one of the RJ-45 connectors on the **DRPC-124-EHL** Series. See

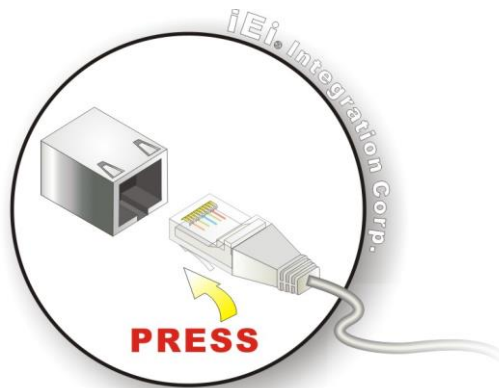

**Figure 3-10: LAN Connection**

**Step 3:** Insert the LAN cable RJ-45 connector. Once aligned, gently insert the LAN cable RJ-45 connector into the on-board RJ-45 connector

The RJ-45 Ethernet connector has two status LEDs, one green and one yellow. The green LED indicates activity on the port and the yellow LED indicates the port is linked.

**DRPC-124-EHL**



**Figure 3-11: RJ-45 Ethernet Connector**

Activity/Link LED		Speed LED	
STATUS	DESCRIPTION	STATUS	DESCRIPTION
Off	No link	Off	10 Mbps connection
Yellow	Linked	Green	100 Mbps connection
Blinking	TX/RX activity	Orange	1 Gbps connection

**Table 3-1: LAN4 GbE RJ-45 Ethernet Connector LEDs**

Activity/Link LED		Speed LED	
STATUS	DESCRIPTION	STATUS	DESCRIPTION
Off	No link	Off	10 Mbps connection
Yellow	Linked	Orange	1000 Mbps connection
Blinking	TX/RX activity	Green	2.5 Gbps connection

**Table 3-2: LAN1-3 2.5GbE RJ-45 Ethernet Connector LEDs**

### 3.7.3 Power Connector

The power connector is a 2-pin Phoenix terminal connector on the rear panel that can directly connect to a power supply. The supported power input voltage is 12-28 VDC.

Pin	Description
1	12-28V
2	GND

**Table 3-3: Power Connector Pinouts**

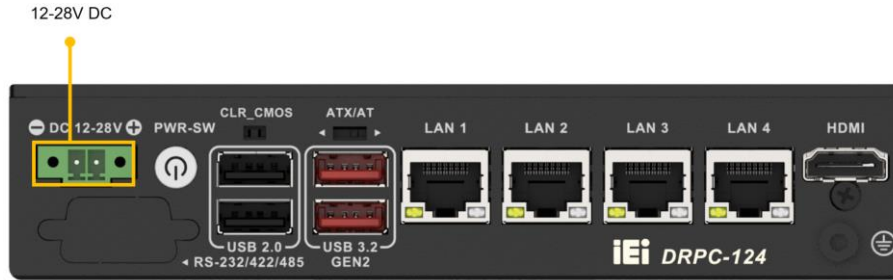

**Figure 3-12: Power Connector**

### 3.7.4 USB Connectors

The DRPC-124-EHL has two USB 3.2 & two USB 2.0 ports. To connect a USB device, please follow the instructions below

**Step 1: Located the USB connectors.** The locations of the USB connectors are shown in Chapter 1

**Step 2: Align the connectors.** Align the USB device connector with one of the connectors on the I/O panel.

**Step 3: Insert the device connector.** Once aligned, gently insert the USB device connector into the onboard connector.

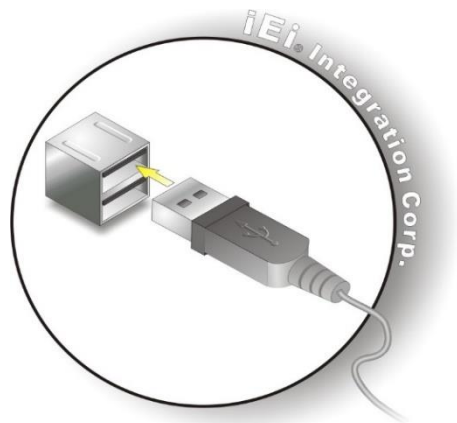

**Figure 3-13: USB Connection**



## DRPC-124-EHL

### 3.8 Powering On/Off the System

**WARNING:**

Make sure a power supply with the correct input voltage is being fed into the system. Incorrect voltages applied to the system may cause damage to the internal electronic components and may also cause injury to the user.

The power of the system needs more than 12-28V 60W.

**Step 1:** Connect the power source to the power input terminal.

**Step 2:** Push the power button.

**Step 3:** Once turned on, the power LED indicator should turn on in orange.

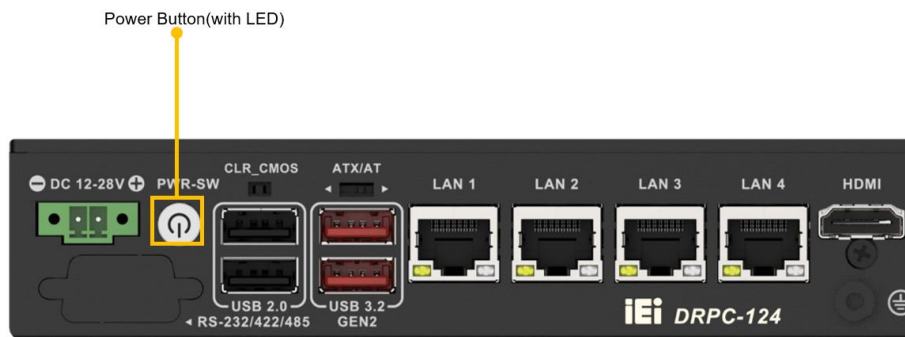
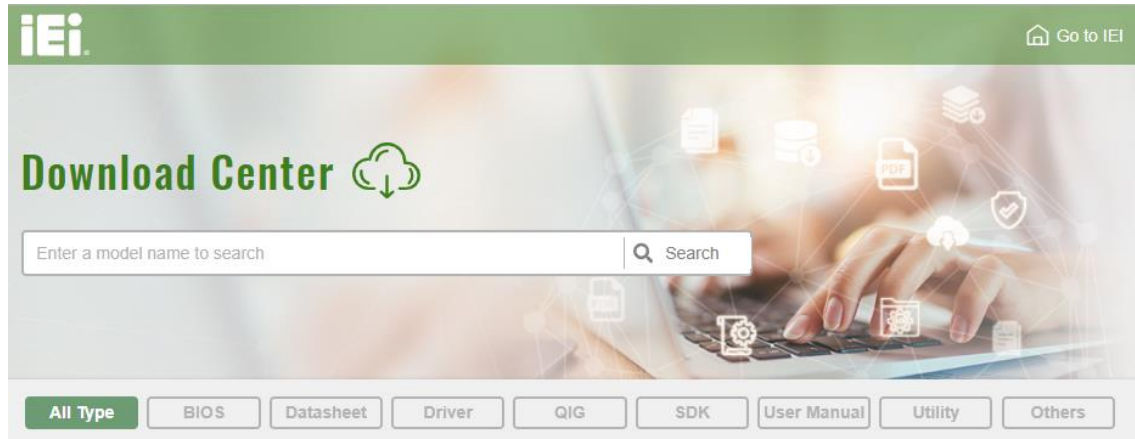

**Figure 3-14:** Power Input

- **Power on** the system: press the power button for 1 seconds
- **Power off** the system: press the power button for 6 seconds

### 3.9 Available Drivers

All the drivers for the DRPC-124-EHL Series are available on IEI Resource Download Center (<https://download.ieiworld.com>). Type DRPC-124-EHL Series and press Enter to find all the relevant software, utilities, and documentation.



#### IEI Resource Download Center

### 3.9.1 Driver Download

To download drivers from IEI Resource Download Center, follow the steps below.

**Step 1:** Go to <https://download.ieiworld.com>. Type DRPC-124-EHL Series and press Enter.

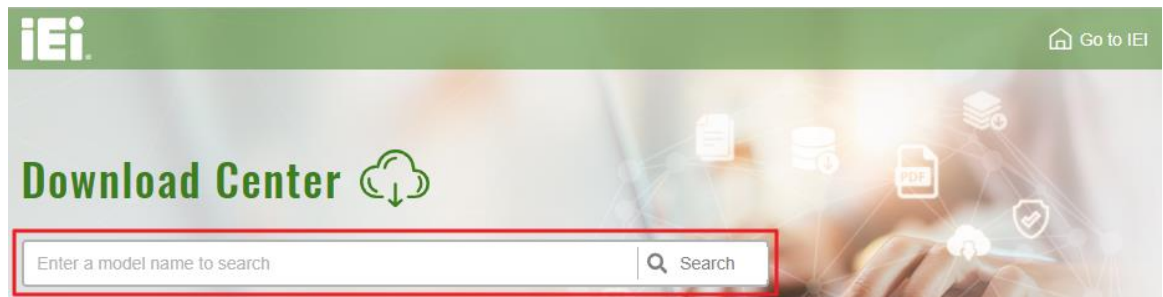

**Step 2:** All product-related software, utilities, and documentation will be listed. You can choose **Driver** to filter the result.

## DRPC-124-EHL

[All Type](#)
[BIOS](#)
[Datasheet](#)
[Driver](#)
[QIG](#)
[SDK](#)
[User Manual](#)
[Utility](#)
[Others](#)

**WAFER-BT-i1** Product Info ▶

[Embedded Computer](#) ▶ [Single Board Computer](#) ▶ [Embedded Board](#)  
 3.5" SBC with Intel® 22nm Atom™/Celeron® on-board SoC

**Driver**

File Name	Published	Version	File Checksum
<a href="#">7B000-001033-RS V2.3.iso (2.23 GB)</a>	2017/10/03	2.30	3B2DB1F792779A93A8F50DDBC3943E30

**Step 3:** Click the driver file name on the page and you will be prompted with the following window. You can download the entire ISO file (❶), or click the small arrow to find an individual driver and click the file name to download (❷).

7B000-001168-RS\_V1.4.iso

❶ [Click here to download entire ISO file. \(2.99 GB\)](#)

\* Download individual file \*

- Docs
  - 1.Chipset
  - 10.1.1.12.zip (2.7 MB)
  - 2.VGA
  - 3.Audio
  - 4.Lan
  - 5.USB 3.0
  - 6.Serial IO
  - 7.TXE
  - 8.Manual



### NOTE:

To install software from the downloaded ISO image file in Windows 10 (or later), double-click the ISO file to mount it as a virtual drive to view its content.

Chapter

4

# System Motherboard

---

## DRPC-124-EHL

### 4.1 Overview

The connectors and jumpers of the system motherboard are listed in the following sections.

### 4.2 Layout

The following diagram shows the locations of the internal/external connectors and jumpers on the motherboard.

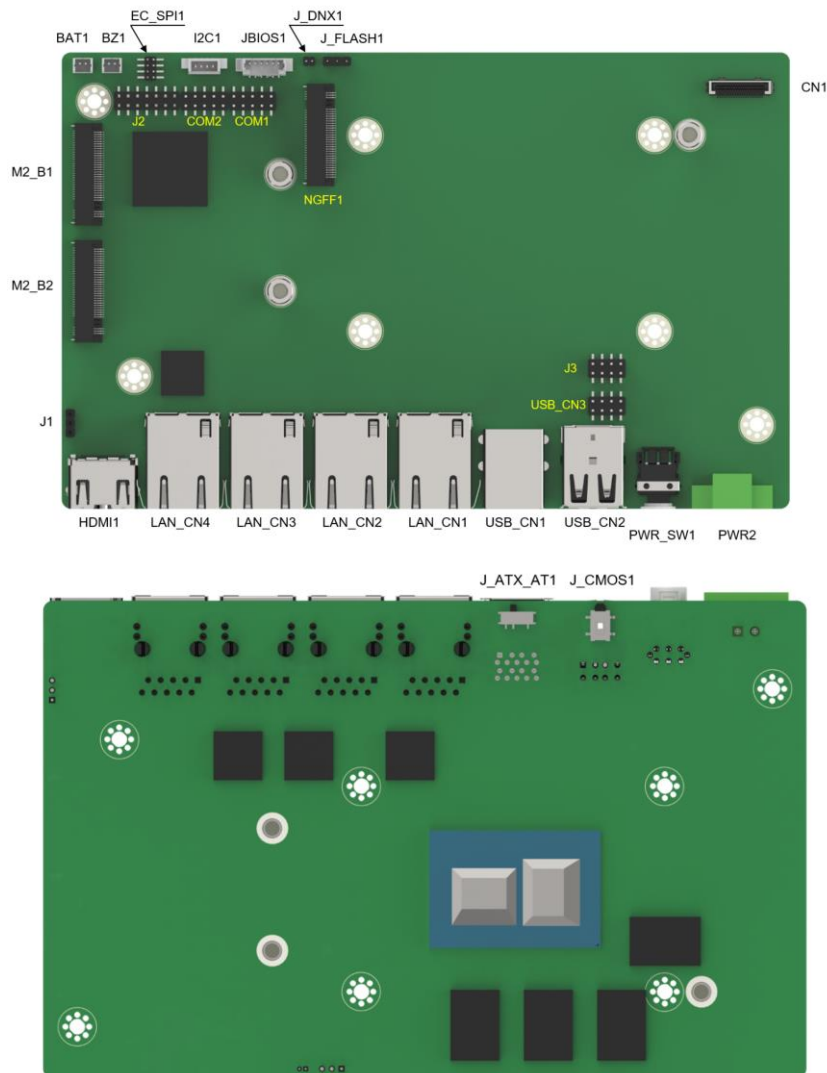

Figure 4-1: Connector and Jumper Locations

### 4.3 Peripheral Interface Connectors

The table below lists all the connectors on the board.

Connector	Type	Label
Clear CMOS button	Button	J_CMOS1
AT/ATX power mode setting	Switch	J_ATX_AT1
Mini SATA Connector	iSATA connector	CN1
Flash descriptor override setting jumper	3-pin header	J_FLASH1
DNX mode setting jumper	2-pin header	J_DNX1
Flash SPI ROM connector	6-pin wafer	JBIOS1
I2C connector	4-pin wafer	I2C1
Flash EC ROM connector	8-pin header	EC_SPI1
Buzzer Connector	2-pin wafer	BZ1
Battery connector	2-pin wafer	BAT1
DIO Connector	14-pin header	J2
RS-232/422/485 serial port connectors	10-pin header	COM1, COM2
HDMI Debug Connector	3-pin header	J1
Front panel connector	8-pin header	J3
Internal USB 2.0 connector	8-pin header	USB_CN3
M.2 B-key slot	M.2 B-key slot	M2_B1, M2_B2
M.2 M-key slot	M.2 M-key slot	NGFF1

**Table 4-1: Peripheral Interface Connectors**

**DRPC-124-EHL**

**4.4 Clear CMOS Button Connector**

- CN Label:** J\_CMOS1
- CN Type:** Button
- CN Location:** See **Figure 4-2**
- CN Pinouts:** See **Table 4-2**

To clear the CMOS Setup (for example if you have forgotten the password, you should clear the CMOS and then reset the password), you should disconnect the RTC battery and press the button for about 3 seconds. This will set back to normal operation mode.

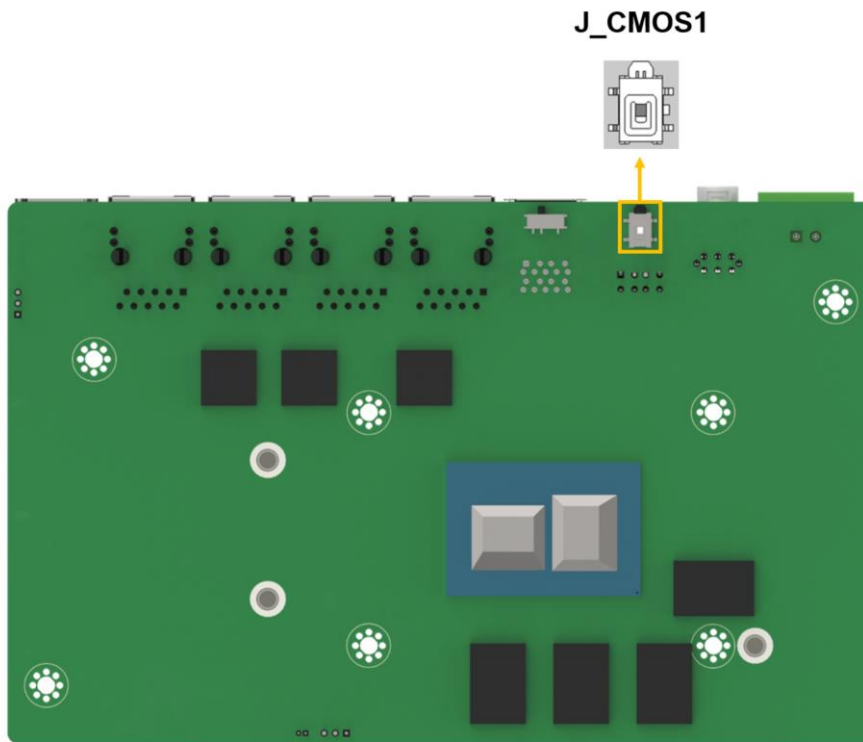

**Figure 4-2: Clear CMOS Location**

PIN NO.	DESCRIPTION
NC (default)	Keep CMOS Setup (Normal Operation)
Press button	Clear CMOS Setup

**Table 4-2: Clear CMOS Pinouts**

### 4.5 AT/ATX Power Mode Setting

- CN Label:** J\_ATX\_AT1
- CN Type:** 3-pin switch
- CN Location:** See **Figure 4-3**
- CN Pinouts:** See **Table 4-3**

The AT/ATX power mode selection is made through the AT/ATX power mode switch which is shown in **Figure 4-3**.

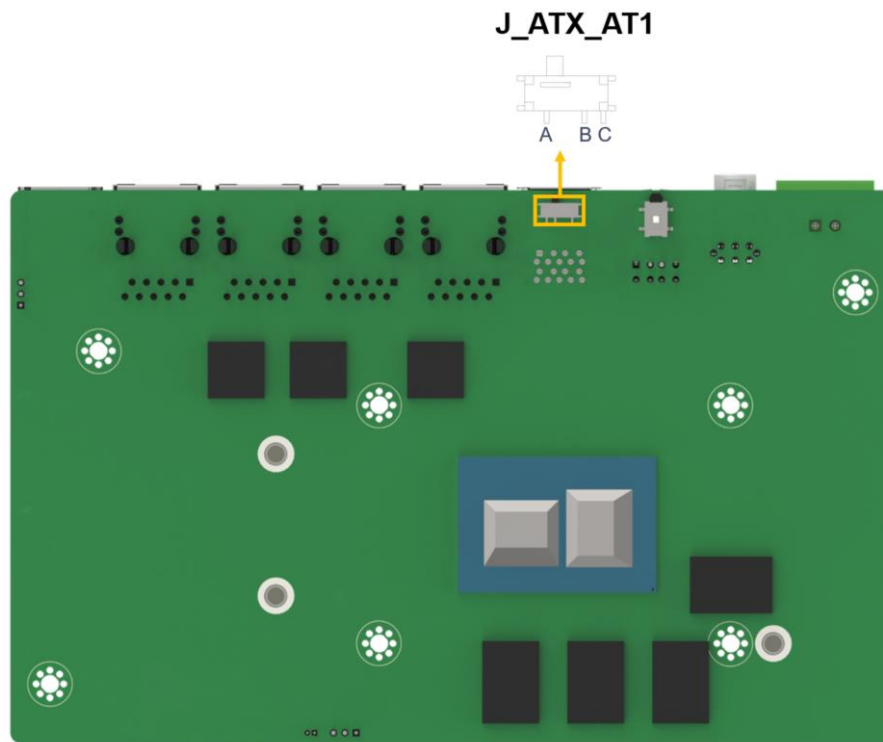

**Figure 4-3: AT/ATX Power Mode Switch Locations**

<b>PIN NO.</b>	<b>DESCRIPTION</b>
Short A - B	ATX Power Mode (default)
Short B - C	AT Power Mode

**Table 4-3: AT/ATX Power Mode Switch Pinouts**



**DRPC-124-EHL**

**4.6 DNX Mode Setting Jumper**

- CN Label:** J\_DNX1
- CN Type:** 2-pin header, P=1.27mm
- CN Location:** See **Figure 4-4**
- CN Pinouts:** See **Table 4-4**

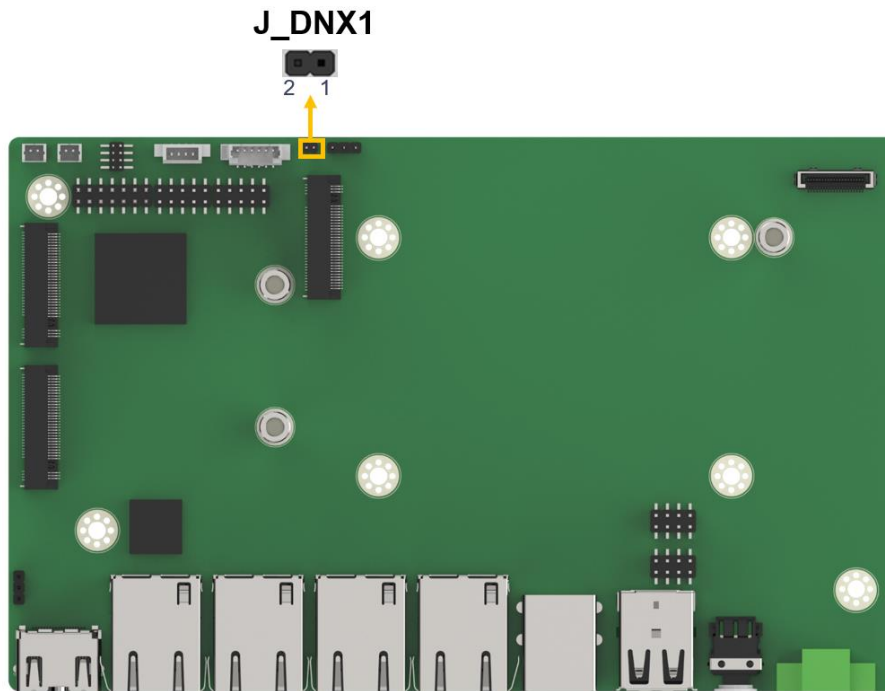

The J\_DNX1 connector is used for set DNX mode.

**Figure 4-4: DNX Mode Setting Jumper Location**

PIN NO.	DESCRIPTION
Open	Normal (default)
Short	Enable DNX Boot

**Table 4-4: DNX Mode setting Jumper Pinouts**

### 4.7 Flash Descriptor Override Setting Jumper

- CN Label:** J\_FLASH1
- CN Type:** 3-pin header, P=2.00mm
- CN Location:** See **Figure 4-5**
- CN Pinouts:** See **Table 4-5**

The J\_FLASH1 connector is used for Flash Descriptor Security Override.

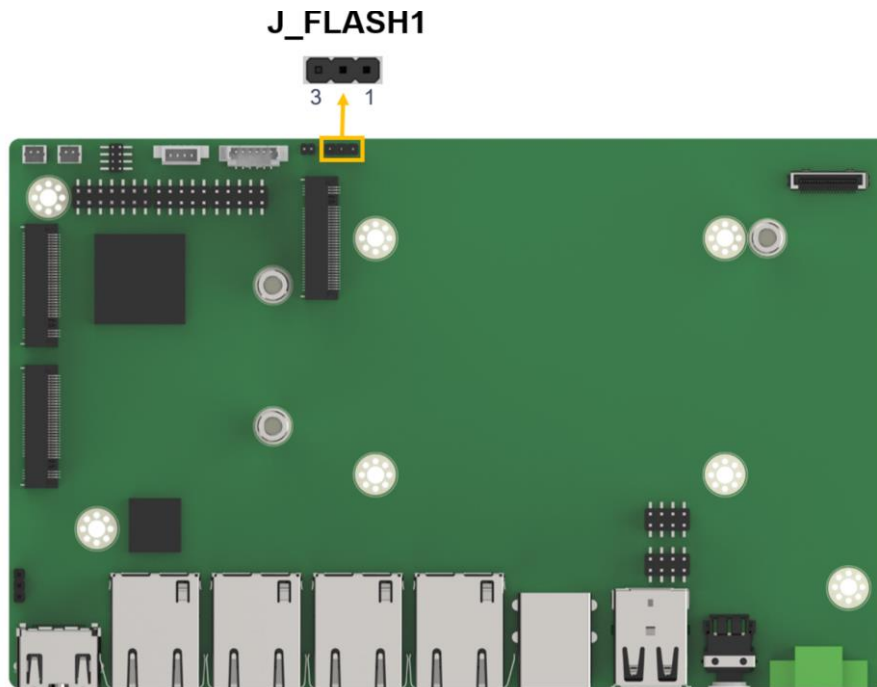

**Figure 4-5: Flash Descriptor Override Setting Jumper Locations**

PIN NO.	DESCRIPTION
Short 1 - 2	Disable (Default)
Short 2 - 3	Enable

**Table 4-5: Flash Descriptor Override Setting Jumper Pinouts**

## DRPC-124-EHL

To update the ME firmware, please follow the steps below.

- Step 1:** Before turning on the system power, short the Flash Descriptor Security Override jumper.
- Step 2:** Update the BIOS and ME firmware, and then turn off the system power.
- Step 3:** Remove the metal clip on the Flash Descriptor Security Override jumper to its default setting.
- Step 4:** Restart the system. The system will reboot 2 ~ 3 times to complete the ME firmware update.

## 4.8 RTC Battery Connector



### CAUTION:

Risk of explosion if battery is replaced by an incorrect type. Only certified engineers should replace the on-board battery.

Dispose of used batteries according to instructions and local regulations.

---



### NOTE:

It is recommended to attach the RTC battery onto the system chassis in which the DRPC-124-EHL Series is installed.

---

<b>CN Label:</b>	<b>BAT1</b>
<b>CN Type:</b>	2-pin wafer, p=1.25 mm
<b>CN Location:</b>	See Figure 4-6
<b>CN Pinouts:</b>	See Table 4-6

The battery connector is connected to the system battery. The battery provides power to the system clock to retain the time when power is turned off.

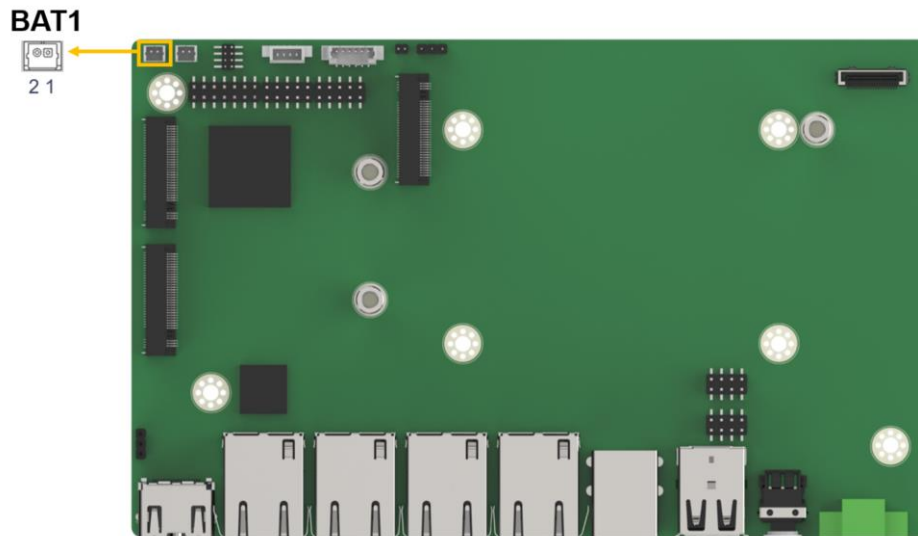

**Figure 4-6: Battery Connector Location**

Pin	Description
1	VBATT
2	GND

**Table 4-6: Battery Connector Pinouts**

## 4.9 Buzzer Connector

- CN Label:** BZ1
- CN Type:** 2-pin wafer, p=1.25 mm
- CN Location:** See Figure 4-7
- CN Pinouts:** See Table 4-7

The buzzer connector is connected with the buzzer to give a beep warning when the motherboard goes wrong.

DRPC-124-EHL

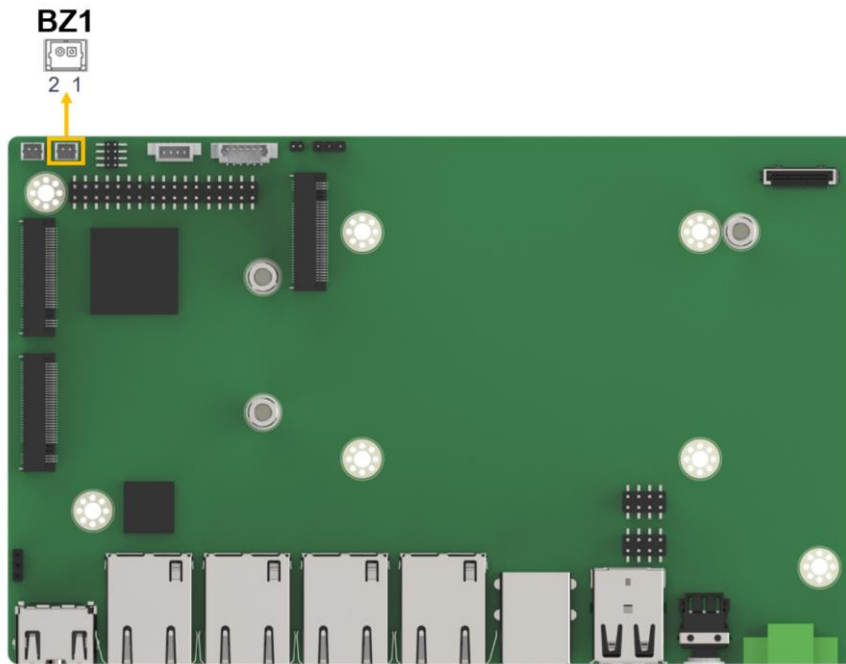

Figure 4-7: Buzzer Connector Location

Pin	Description
1	+5V
2	PC_BEEP

Table 4-7: Buzzer Connector Pinouts

### 4.10 RS-232/422/485 Serial Port Connector

- CN Label:** COM1, COM2
- CN Type:** 10-pin header, p=2.00 mm
- CN Location:** See **Figure 4-8**
- CN Pinouts:** See **Table 4-8**

The serial connector provides RS-232/422/485 connection.

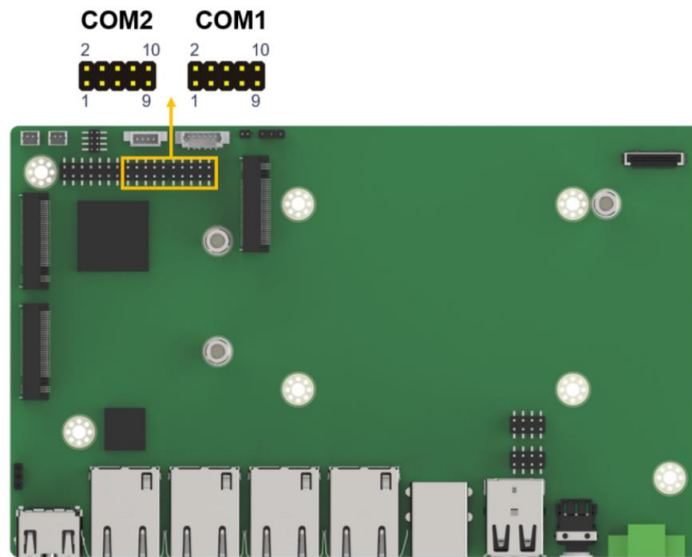

**Figure 4-8: RS-232/422/485 Serial Port Connector Location**

Pin	RS232	RS422	RS485
1	DCD#	TX-	TX-
2	DSR#		
3	RXD	TX+	TX+
4	RTS#		
5	TXD	RX+	
6	CTS#		
7	DTR#	RX-	
8	RI#		
9	GND		

**Table 4-8: RS-232/422/485 (COM1-2) Connector Pinouts**

**DRPC-124-EHL**

Use the optional RS-232/422/485 cable to connect to a serial device. The pinouts of the DB-9 connector are listed below.

RS-232 Pinouts	RS-422 Pinouts	RS-485 Pinouts
<p><b>MODE 01</b></p>	<p><b>MODE 00</b></p>	<p><b>MODE 10/11</b></p>

### 4.11 Mini SATA Connector

- CN Label:** CN1
- CN Type:** 20-pin Mini SATA connector
- CN Location:** See **Figure 4-9**
- CN Pinouts:** See **Table 4-9**

The SATA 6Gb/s drive connector is connected to a SATA 6Gb/s drive. The SATA 6Gb/s drive transfers data at speeds as high as 6Gb/s.

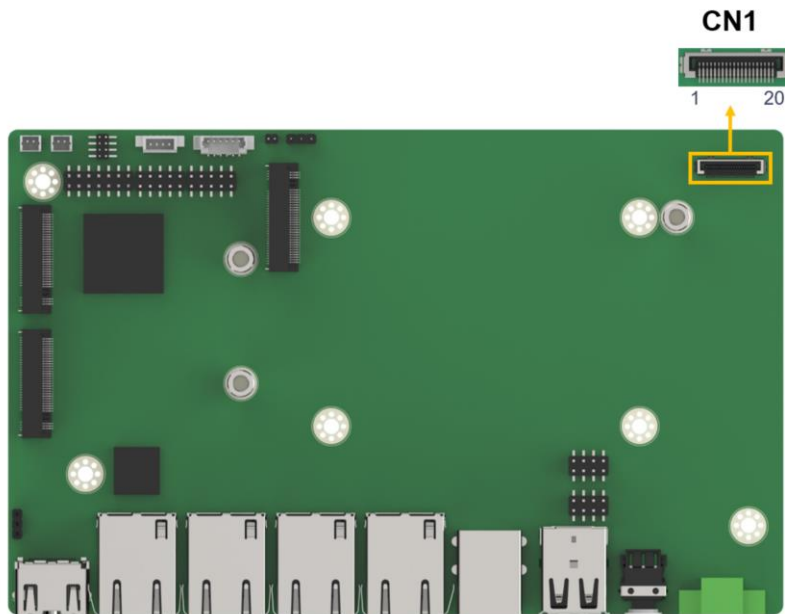

**Figure 4-9: Mini SATA Connectors Location**

<b>PIN NO.</b>	<b>DESCRIPTION</b>	<b>PIN NO.</b>	<b>DESCRIPTION</b>
1	GND	11	+5VS
2	GND	12	N/C
3	GND	13	N/C
4	GND	14	GND
5	GND	15	SATA RX+
6	GND	16	SATA_RX-
7	+5VS	17	GND
8	+5VS	18	SATA_TX-



**DRPC-124-EHL**

9	+5VS	19	SATA_TX+
10	+5VS	20	GND

**Table 4-9: SATA 6Gb/s Drive Connectors Pinouts**

**4.12 Flash SPI ROM Connector**

- CN Label:** JBIOS1
- CN Type:** 6-pin wafer, p=1.25 mm
- CN Location:** See **Figure 4-10**
- CN Pinouts:** See **Table 4-10**

The 6-pin Flash SPI ROM connector is used to flash the BIOS.

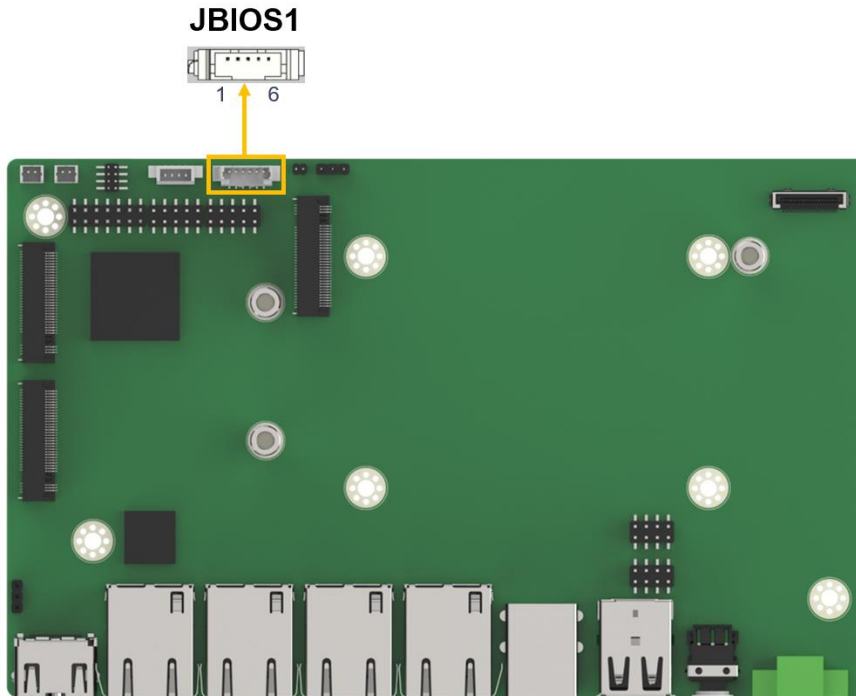

**Figure 4-10: Flash SPI ROM Connector Location**

Pin	Description
1	+3.3V
2	SPI_CS#
3	SPI SO
4	SPI CLK

Pin	Description
5	SPI SI
6	GND

**Table 4-10: Flash SPI ROM Connector Pinouts**

### 4.13 Flash EC ROM Connector

- CN Label:** EC\_SPI1
- CN Type:** 8-pin header, p=1.27 mm
- CN Location:** See Figure 4-11
- CN Pinouts:** See Table 4-11

The 8-pin Flash EC ROM connector is used to flash the EC internal ROM.

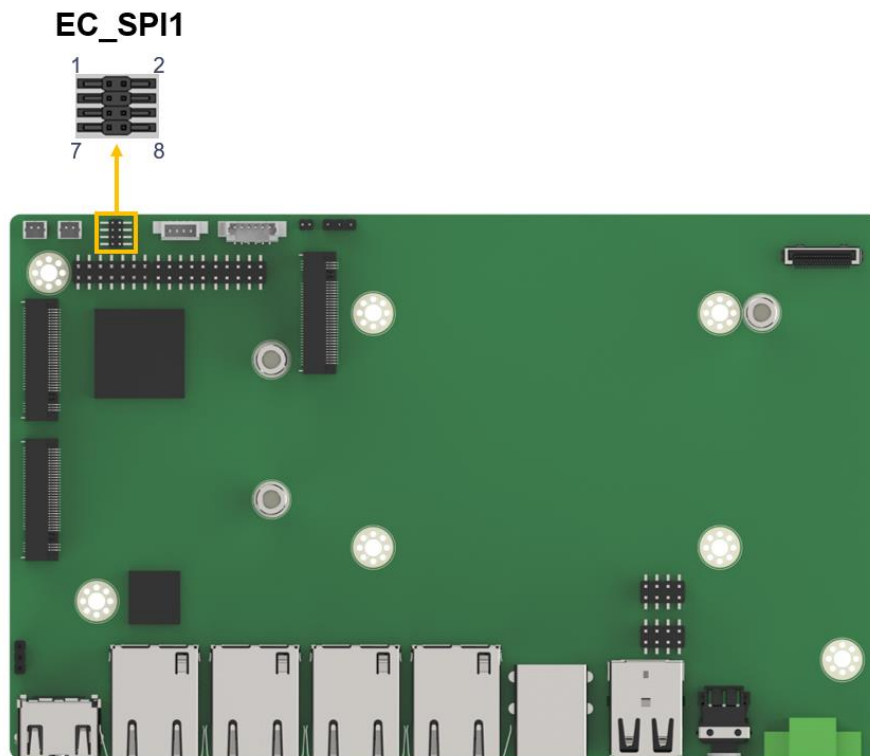

**Figure 4-11: Flash EC ROM Connector Location**

**DRPC-124-EHL**

Pin	Description	Pin	Description
1	SPI_CS#	2	+3.3V
3	SPI_SO	4	NC
5	EC_DET_FLASH	6	SPI_CLK
7	GND	8	SPI_SI

**Table 4-11: Flash EC ROM Connector Pinouts**

**4.14 I<sup>2</sup>C Connector**

- CN Label:** I2C1
- CN Type:** 4-pin wafer, p=1.25 mm
- CN Location:** See **Figure 4-12**
- CN Pinouts:** See **Table 4-12**

The SMBus (System Management Bus) connector provides low-speed system management communications.

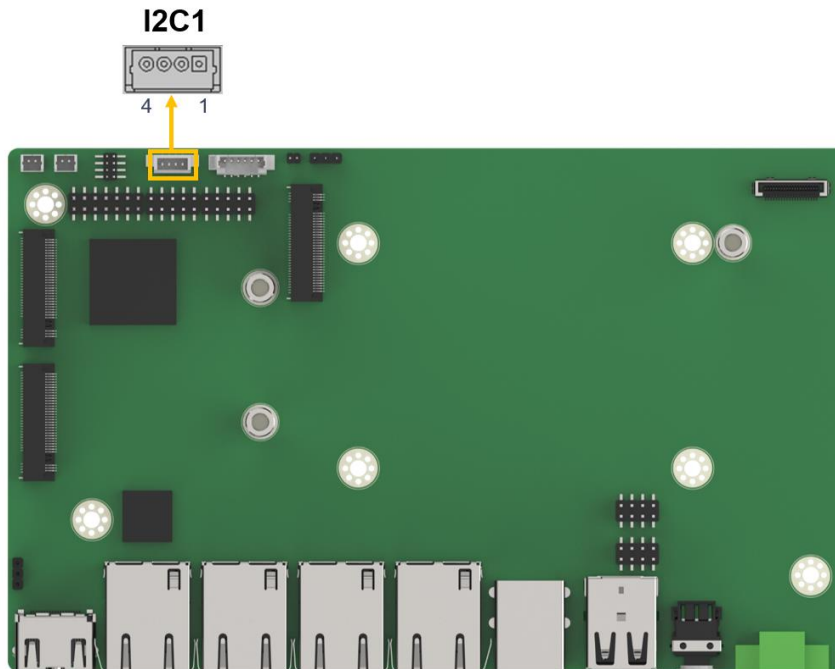

**Figure 4-12: I<sup>2</sup>C Connector Location**

Pin	Description
1	GND
2	I2C_DATA
3	I2C_CLK
4	+5V

**Table 4-12: I<sup>2</sup>C Connector Pinouts**

### 4.15 HDMI Debug Connector

- CN Label:** J1
- CN Type:** 3-pin header, p=2.00 mm
- CN Location:** See Figure 4-13
- CN Pinouts:** See Table 4-13

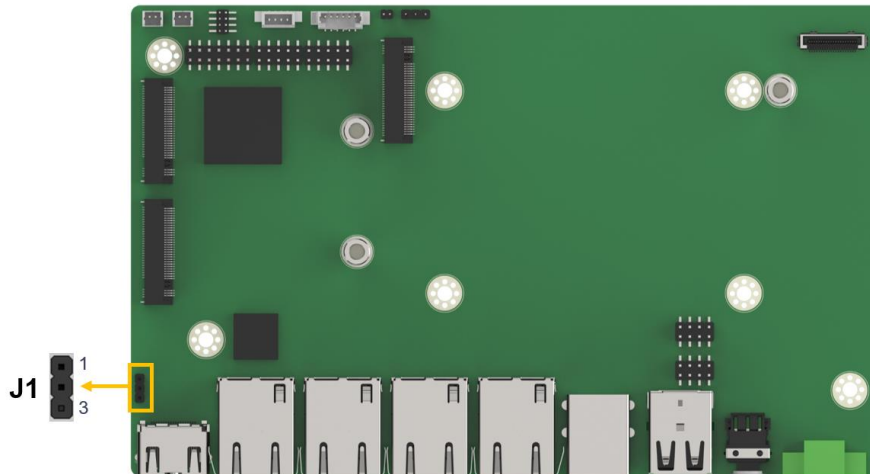

**Figure 4-13: HDMI Debug Connector Location**

Pin	Description	Pin	Description
1	CSDA	3	GND
2	CSCL		

**Table 4-13: HDMI Debug Connector Pinouts**

**DRPC-124-EHL**

**4.16 Internal USB 2.0 Connectors**

- CN Label:** USB\_CN3
- CN Type:** 8-pin header, p=2.00 mm
- CN Location:** See **Figure 4-14**
- CN Pinouts:** See **Table 4-14**

Each USB connector provides two USB 2.0 ports by dual-port USB cable.

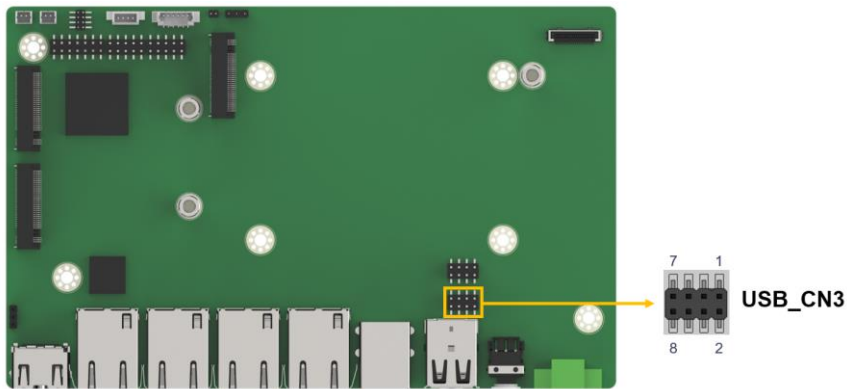

**Figure 4-14: Internal USB 2.0 Connectors Locations**

<b>PIN NO.</b>	<b>DESCRIPTION</b>	<b>PIN NO.</b>	<b>DESCRIPTION</b>
1	VCC	2	GND
3	USB DATA-	4	USB DATA+
5	USB DATA+	6	USB DATA-
7	GND	8	VCC

**Table 4-14: Internal USB 2.0 Connectors Pinouts**

**4.17 Digital Input / Output Connector**

- CN Label:** J2
- CN Type:** 14-pin header, p=2.0 mm
- CN Location:** See **Figure 4-15**
- CN Pinouts:** See **Table 4-15**

The 12-bit digital I/O connector provides programmable input and output for external devices.

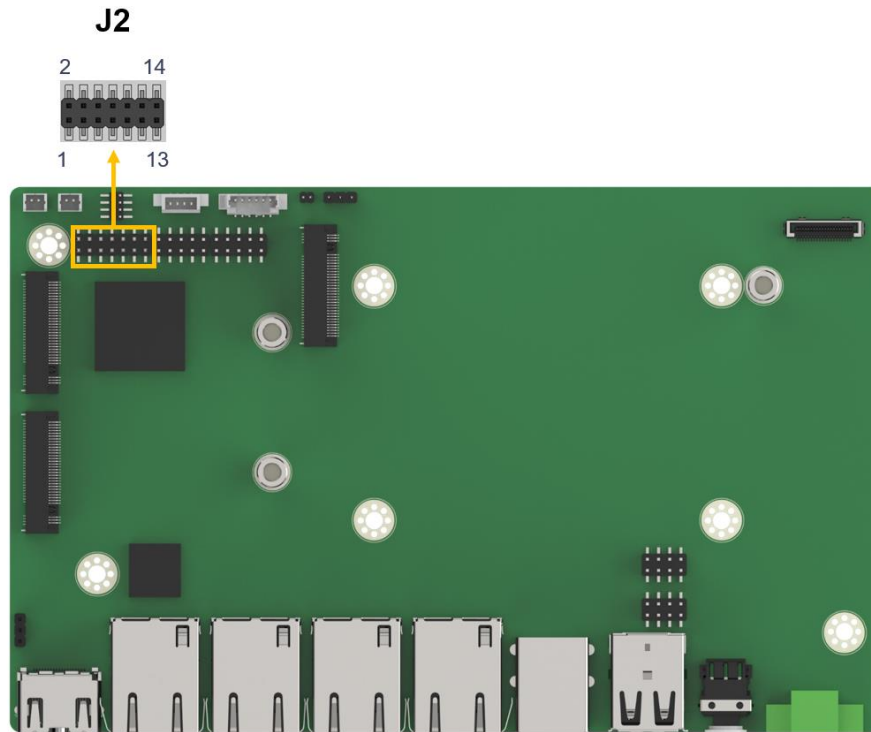

**Figure 4-15: Digital I/O Connector Location**

PIN NO.	DESCRIPTION	PIN NO.	DESCRIPTION
1	GND	2	VCC
3	DOUT5	4	DOUT4
5	DOUT3	6	DOUT2
7	DOUT1	8	DOUT0
9	DIN5	10	DIN4
11	DIN3	12	DIN2
13	DIN1	14	DIN0

**Table 4-15: Digital I/O Connector Pinouts**

### 4.18 Front Panel Connector

- CN Label:** J3
- CN Type:** 8-pin header, p=2.0 mm

**DRPC-124-EHL**

**CN Location:** See **Figure 4-16**

**CN Pinouts:** See **Table 4-16**

The front panel connector connects to the indicator LEDs & reset button on the system front panel.

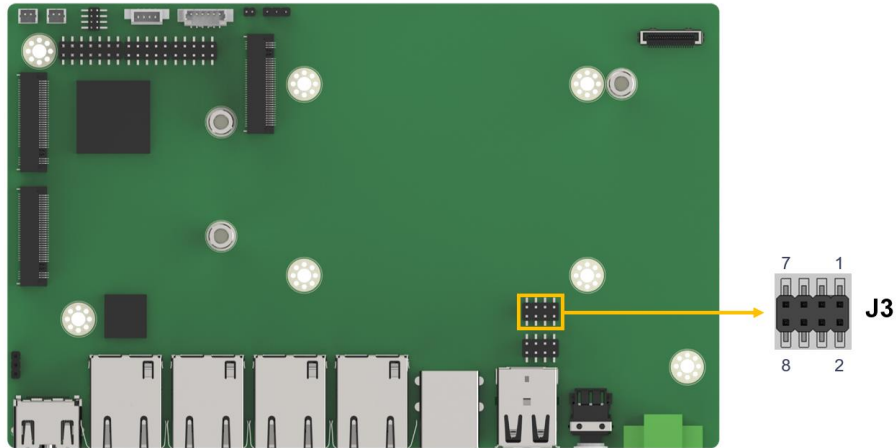

**Figure 4-16: Front panel Connector Location**

PIN NO.	DESCRIPTION	PIN NO.	DESCRIPTION
1	GND	2	PWRBTN_N
3	GND	4	PM_SYSRST_R#
5	GND	6	+V5S
7	SATA_LED#	8	+V5S

**Table 4-16: Front panel Connector Pinouts**

### 4.19 M.2 B-key Slot (B1)

- CN Label:** M2\_B1
- CN Type:** M.2 B-key slot
- CN Location:** See **Figure 4-17**
- CN Pinouts:** See **Table 4-17**

The M.2 B key (2242) slot with PCIe Gen3 x2 signals.

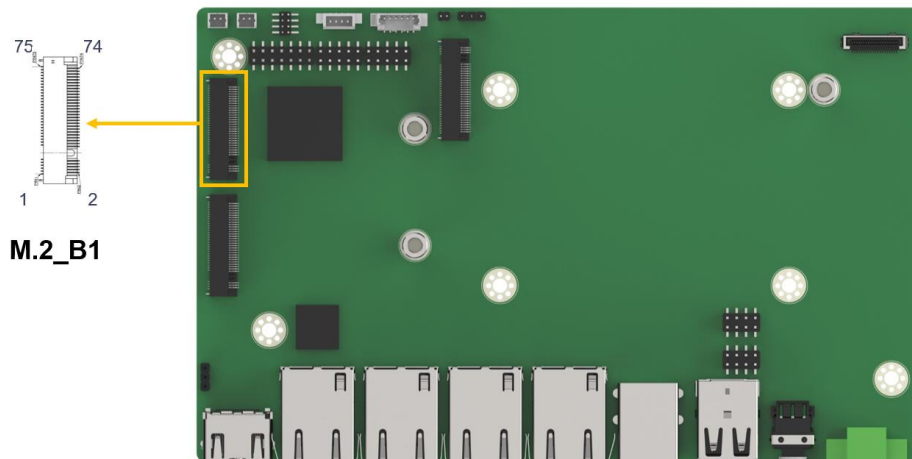

**Figure 4-17: M.2 B-key Slot Location**

Pin	Description	Pin	Description
1	GND	2	+V3.3_B1
3	GND	4	+V3.3_B1
5	GND	6	NC
7	NC	8	+V3.3_B1
9	NC	10	M2M_LED_N
11	GND	12	NC
13	Module Key	14	Module Key
15	Module Key	16	Module Key
17	Module Key	18	Module Key
19	Module Key	20	Module Key
21	GND	22	NC
23	NC	24	NC
25	NC	26	NC



**DRPC-124-EHL**

<b>Pin</b>	<b>Description</b>	<b>Pin</b>	<b>Description</b>
27	GND	28	NC
29	PCIE_RXN7	30	NC
31	PCIE_RXP7	32	NC
33	GND	34	NC
35	PCIE_TXN7	36	NC
37	PCIE_TXP7	38	NC
39	GND	40	M.2_SMCLK
41	PCIE_RXN6	42	M.2_SMDAT
43	PCIE_RXP6	44	NC
45	GND	46	NC
47	PCIE_TXN6	48	NC
49	PCIE_TXP6	50	PLT_RST_N
51	GND	52	NC
53	CLK_M2_B_N	54	NC
55	CLK_M2_B_P	56	NC
57	GND	58	NC
59	NC	60	NC
61	NC	62	NC
63	NC	64	NC
65	NC	66	NC
67	NC	68	NC
69	GND	70	+V3.3_B1
71	GND	72	+V3.3_B1
73	GND	74	+V3.3_B1
75	GND		

**Table 4-17: M.2 B-Key Slot Pinouts**

### 4.20 M.2 B-key Slot (B2)

- CN Label:** M2\_B2
- CN Type:** M.2 B-key slot
- CN Location:** See **Figure 4-18**
- CN Pinouts:** See **Table 4-18**

The M.2 B key (2242) slot with SATA signal.

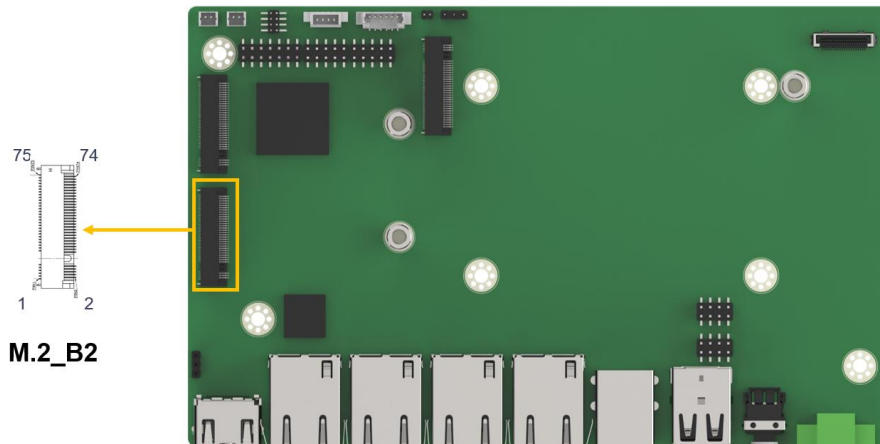

**Figure 4-18: M.2 B-key Slot Location**

Pin	Description	Pin	Description
1	GND	2	+V3.3_B2
3	GND	4	+V3.3_B2
5	GND	6	NC
7	NC	8	NC
9	NC	10	+V3.3_B2
11	GND	12	NC
13	Module Key	14	Module Key
15	Module Key	16	Module Key
17	Module Key	18	Module Key
19	Module Key	20	Module Key
21	GND	22	NC
23	NC	24	NC
25	NC	26	NC

Pin	Description	Pin	Description
27	GND	28	NC
29	NC	30	NC
31	NC	32	NC
33	GND	34	NC
35	NC	36	NC
37	NC	38	NC
39	GND	40	M.2_SMCLK
41	SATA_RX0+	42	M.2_SMDAT
43	SATA_RX0-	44	NC
45	GND	46	NC
47	SATA_RX0+	48	NC
49	SATA_RX0-	50	PLT_RST_N
51	GND	52	NC
53	NC	54	NC
55	NC	56	NC
57	GND	58	NC
59	NC	60	NC
61	NC	62	NC
63	NC	64	NC
65	NC	66	NC
67	NC	68	NC
69	GND	70	+V3.3_B2
71	GND	72	+V3.3_B2
73	GND	74	+V3.3_B2
75	GND		

Table 4-18: M.2 B-Key Slot Pinouts

### 4.21 M.2 M-key Slot

- CN Label:** NGFF1
- CN Type:** M.2 M-key slot
- CN Location:** See Figure 4-19
- CN Pinouts:** See Table 4-19

The M.2 M key (2280) slot with PCIe Gen3 x2 supports NVMe storage.

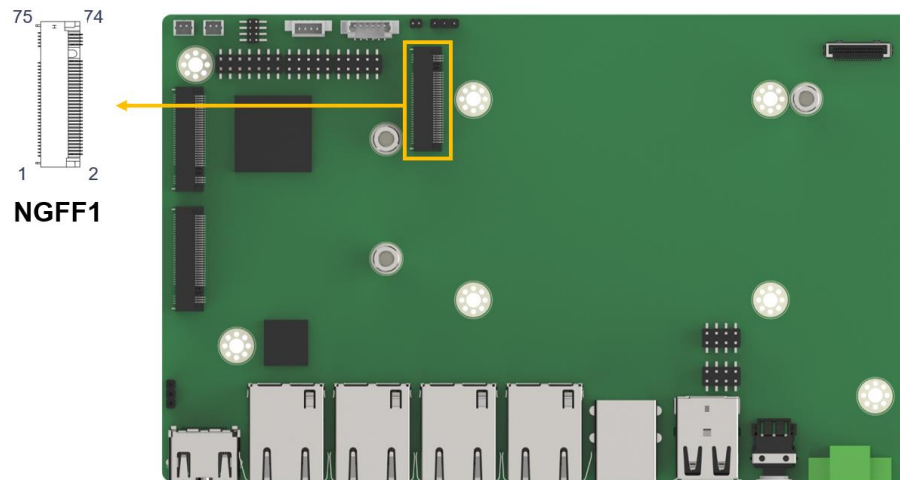

**Figure 4-19: M.2 M-key Slot Location**

PIN NO.	DESCRIPTION	PIN NO.	DESCRIPTION
1	GND	2	+V3P3S_SSD
3	GND	4	+V3P3S_SSD
5	NC	6	NC
7	NC	8	NC
9	GND	10	M2M_LED_N
11	NC	12	+V3P3S_SSD
13	NC	14	+V3P3S_SSD
15	GND	16	+V3P3S_SSD
17	NC	18	+V3P3S_SSD
19	NC	20	NC
21	GND	22	NC
23	NC	24	NC
25	NC	26	NC
27	GND	28	NC
29	PCIE_RXN5	30	NC
31	PCIE_RXP5	32	NC
33	GND	34	NC
35	PCIE_TXN5_C	36	NC
37	PCIE_TXP5_C	38	M_1_SSD_SLP

## DRPC-124-EHL

39	GND	40	M.2_SMCLK
41	PCIE_RXN4	42	M.2_SMDAT
43	PCIE_RXP4	44	NC
45	GND	46	NC
47	PCIE_TXN4	48	NC
49	PCIE_TXP4	50	PLT_RST_N
51	GND	52	PLT_RST_N
53	CLK_M2_M_N	54	TP320
55	CLK_M2_M_P	56	N/C
57	GND	58	N/C
59	Module Key	60	Module Key
61	Module Key	62	Module Key
63	Module Key	64	Module Key
65	Module Key	66	Module Key
67	NC	68	TP321
69	NC	70	+V3P3S_SSD
71	GND	72	+V3P3S_SSD
73	GND	74	+V3P3S_SSD
75	GND		

**Table 4-19: M.2 B-key Slot Pinouts**

Chapter

**5**

**BIOS**

---

## 5.1 Introduction

The BIOS is programmed onto the BIOS chip. The BIOS setup program allows changes to certain system settings. This chapter outlines the options that can be changed.



### NOTE:

Some of the BIOS options may vary throughout the life cycle of the product and are subject to change without prior notice.

---

### 5.1.1 Starting Setup

The UEFI BIOS is activated when the computer is turned on. The setup program can be activated in one of two ways.

1. **Using keyboard:** Press the **DEL** or **F2** as soon as the system is turned on.
2. **Using touchscreen:** Press the **Setup** button on the upper right corner of the BIOS Starting Menu.

If the message disappears before the **DEL** or **F2** key is pressed, restart the computer and try again, then the BIOS Starting Menu will appear. Select "Setup" and press Enter to get into the BIOS Setup.

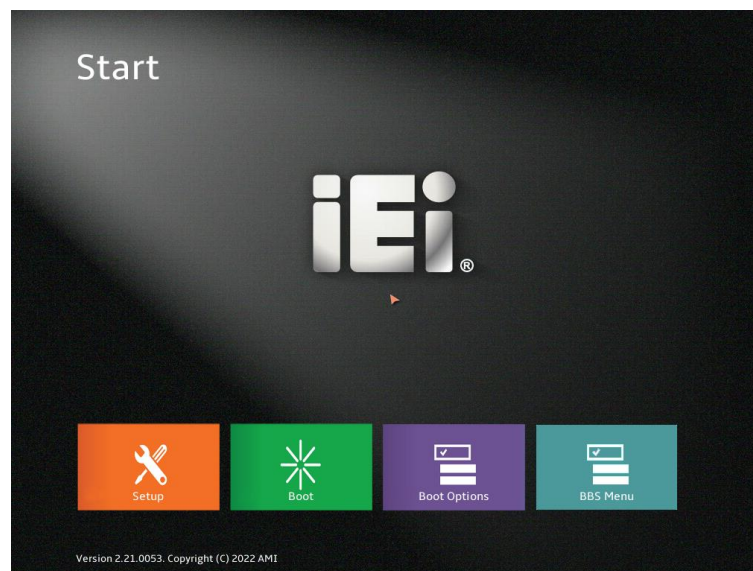

Figure 5-1: BIOS Starting Menu

## 5.1.2 Using Setup

The BIOS Setup menu can be navigated by using a keyboard or a touchscreen.

### 5.1.2.1 Keyboard Navigation

For keyboard navigation, use the navigation keys shown in (Figure 5-2).

Key	Function
Up arrow	Move to previous item
Down arrow	Move to next item
Left arrow	Move to the item on the left hand side
Right arrow	Move to the item on the right hand side
+	Increase the numeric value or make changes
-	Decrease the numeric value or make changes
Page Up	Move to the previous page
Page Dn	Move to the next page
Esc	Main Menu – Quit and not save changes into CMOS Status Page Setup Menu and Option Page Setup Menu -- Exit current page and return to Main Menu
F1	General help, only for Status Page Setup Menu and Option Page Setup Menu
F2	Load previous values
F3	Load optimized defaults
F4	Save changes and Exit BIOS
<K>	Scroll help area upwards
<M>	Scroll help area downwards

**Figure 5-2: BIOS Navigation Keys**



### 5.1.2.2 Touch Navigation

For touchscreen navigation, use the on-screen navigation keys shown below (Figure 5-3).

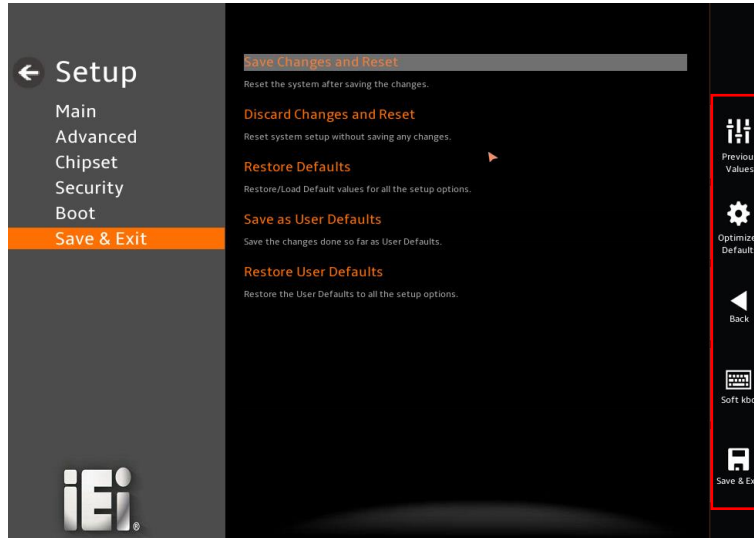

On-screen Button	Function
Previous Values	Load the last value you set.
Optimized Defaults	Load the factory default values in order to achieve the best performance.
Back	Return to the previous menu.
Soft kbd	Display the on-screen keyboard.
Save & Exit	Save the changes made to the BIOS options and reset the system.

Figure 5-3: BIOS On-screen Navigation Keys

### 5.1.3 Getting Help

When **F1** is pressed a small help window describing the appropriate keys to use and the possible selections for the highlighted item appears. To exit the Help Window, press the **Esc** key.

### 5.1.4 Unable to Reboot after Configuration Changes

If the computer cannot boot after changes to the system configuration is made, CMOS defaults. Use the clear CMOS button described in **Chapter 4**.

### 5.1.5 BIOS Menu Bar

The **menu bar** on top of the BIOS screen has the following main items:

- Main – Changes the basic system configuration.
- Advanced – Changes the advanced system settings.
- Chipset – Changes the chipset settings.
- Security – Sets User and Supervisor Passwords.
- Boot – Changes the system boot configuration.
- Save & Exit – Selects exit options and loads default settings

The following sections completely describe the configuration options found in the menu items at the top of the BIOS screen and listed above.

## 5.2 Main

The **Main** BIOS menu (**BIOS Menu 1 & BIOS Menu 2**) appears when the **BIOS Setup** program is entered. The **Main** menu gives an overview of the basic system information.



### BIOS Menu 1: Main (1/2)

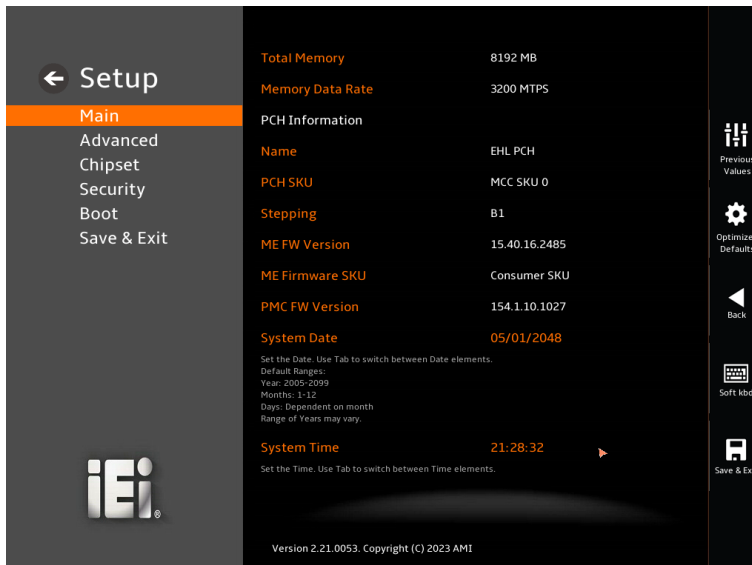

### BIOS Menu 2: Main (2/2)

#### ➔ BIOS Information

The **BIOS Information** lists a brief summary of the BIOS. The fields in **BIOS Information** cannot be changed. The items shown in the system overview include:

- **BIOS Vendor:** Installed BIOS vendor
- **Core Version:** Current BIOS version
- **Compliance:** Current UEFI & PI version
- **Project Version:** the board version
- **Build Date and Time:** Date the current BIOS version was made
- **Access Level:** Administrator
- **EC Version:** Current EC version

#### → Compute Die Information

The **Processor Information** lists a brief summary of the Processor. The fields in **Processor Information** cannot be changed. The items shown in the system overview include:

- **Name:** Displays the Processor Details
- **Type:** Displays the Processor Type
- **Speed:** Displays the Processor Speed
- **ID:** Displays the Processor ID
- **Stepping:** Displays the Processor Stepping
- **Package:** Displays the Processor Package
- **Number of Processors:** Displays number of CPU cores
- **Microcode Revision:** CPU Microcode Revision
- **GT Info:** Processor GT info. Only valid if SNB stepping is D0 or above
- **IGFX GOP Version:** Displays the IGFX GOP Version
- **Total Memory:** Total Memory in the System
- **Memory Data Rate:** Displays the Rate of Memory Data

#### → PCH Information

The **PCH Information** lists a brief summary of the PCH. The fields in **PCH Information** cannot be changed. The items shown in the system overview include:

- **Name:** Displays the PCH Name
- **PCH SKU:** Displays the PCH SKU
- **Stepping:** Displays the PCH Stepping
- **ME FW Version:** Displays the ME Firmware Version
- **ME Firmware SKU:** Displays the ME Firmware SKU

## DRPC-124-EHL

- **PMC FW Version:** Displays the PMC Firmware Version

The System Overview field also has two user configurable fields:

→ **System Date [xx:xx:xx]**

Use the **System Date** option to set the system date. Manually enter the day, month and year.

→ **System Time [xx:xx:xx]**

Use the **System Time** option to set the system time. Manually enter the hours, minutes and seconds.

### 5.3 Advanced

Use the **Advanced** menu (**BIOS Menu 3**) to configure the CPU and peripheral devices through the following sub-menus



#### **WARNING!**

Setting the wrong values in the sections below may cause the system to malfunction. Make sure that the settings made are compatible with the hardware.

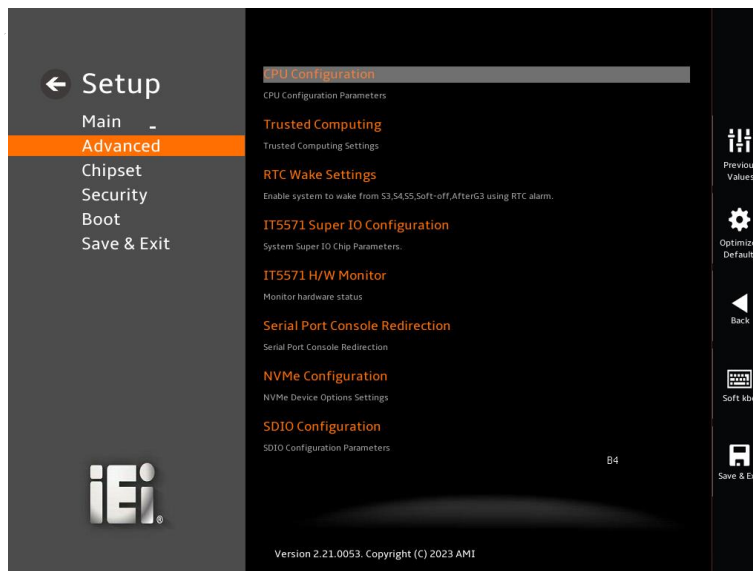

**BIOS Menu 3: Advanced**

### 5.3.1 CPU Configuration

Use the **CPU Configuration** menu (**BIOS Menu 4 & BIOS Menu 5 & BIOS Menu 6**) to view detailed CPU specifications or enable the Intel Virtualization Technology.



#### BIOS Menu 4: CPU Configuration (1/3)



#### BIOS Menu 5: CPU Configuration (2/3)

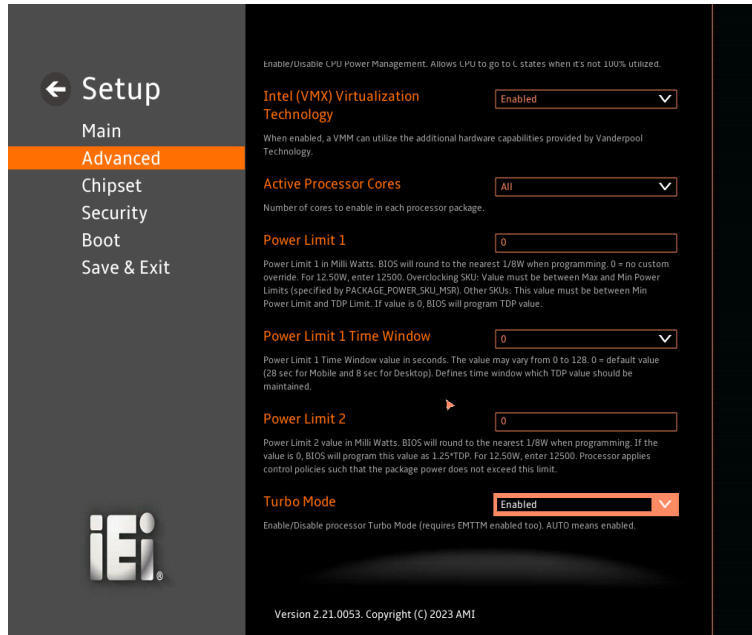

**BIOS Menu 6: CPU Configuration (3/3)**

➔ **Intel(R) SpeedStep(tm) [Enabled]**

Use the **Intel(R) SpeedStep(tm)** option to enable more than two frequency ranges to be supported.

- ➔ **Disabled** Disables more than two frequency ranges
- ➔ **Enabled** **DEFAULT** Enables more than two frequency ranges

➔ **C states [Disabled]**

Use the **C states** option to enable or disable the CPU Power Management.

- ➔ **Disabled** **DEFAULT** Disables CPU to go to C states when it's not 100% utilized.
- ➔ **Enabled** Enables CPU to go to C states when it's not 100% utilized.



### → Intel (VMX) Virtualization Technology [Disabled]

Use the **Intel (VMX) Virtualization Technology** option to enable or disable virtualization on the system. When combined with third party software, Intel® Virtualization technology allows several OSs to run on the same system at the same time.

- |   |                 |                |   |
|---|-----------------|----------------|---|
| → | <b>Disabled</b> |                | Disables Intel Virtualization Technology. |
| → | <b>Enabled</b>  | <b>DEFAULT</b> | Enables Intel Virtualization Technology.  |

### → Active Processor Cores [All]

Use the **Active Processor Cores** BIOS option to enable numbers of cores in the processor package.

- |   |            |                |  |
|---|------------|----------------|--|
| → | <b>All</b> | <b>DEFAULT</b> | Enable all cores in the processor package.   |
| → | <b>1</b>   |                | Enable one core in the processor package.    |
| → | <b>2</b>   |                | Enable two cores in the processor package.   |
| → | <b>3</b>   |                | Enable three cores in the processor package. |

### → Power Limit 1

Use the Power Limit 1 to set Power Limit in Milli Watts. BIOS will round to the nearest 1/8W when programming. 0 = no custom override. For 12.50W, enter 12500. Overclocking SKU: Value must be between Max and Min Power Limits. Other SKUs: This value must be between Min Power limit and TDP Limit. If value is 0, BIOS will program TDP value.

### → Power Limit 1 Time Window

Power Limit 1 Time Window value in second. The value may vary from 0 to 128.0, 0 = default value (28 sec for mobile and 8 sec for desktop). Defines time window which TDP value should be maintained.

### → Power Limit 2

Use the Power Limit 2 to set Power Limit in Milli Watts. BIOS will round to the nearest 1/8W when programming. If the value is 0, BIOS will program this value as 1.25\*TDP. For 12.50W, enter 12500. Processor applies control policies such that the package power does not exceed this limit.

→ **Turbo Mode [Enabled]**

Use the **Turbo Mode** option to enable or disable Turbo Mode which requires Intel Speed Step or Intel Speed Shift to be available and enabled.

- **Disabled** Disables Turbo Mode Technology
- **Enabled** **DEFAULT** Enables Turbo Mode Technology

### 5.3.2 Trusted Computing

The **Trusted Computing** menu (**BIOS Menu 7**) to configure settings related to the Trusted Computing Group (TCG) Trusted Platform Module (TPM).

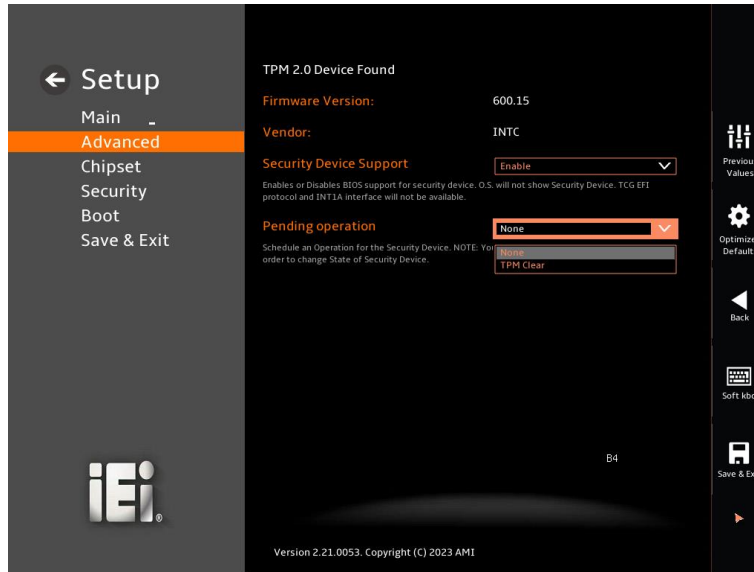

#### BIOS Menu 7: Trusted Computing

##### ➔ Security Device Support [Enable]

Use the Security Device Support option to configure support for the Security Device.

- ➔ **Disable** Security Device support is disabled.
- ➔ **Enable**      **DEFAULT**      Security Device is enabled.

##### ➔ Pending Operation [None]

Use the **Pending Operation** option to schedule an operation for the security device.

- ➔ **None**      **DEFAULT**      TPM information is previous.
- ➔ **TPM Clear**      TPM information is cleared

### 5.3.3 IT5571 Super IO Configuration

Use the **IT5571 Super IO Configuration** menu (BIOS Menu 8) to set or change the configurations for the serial ports.

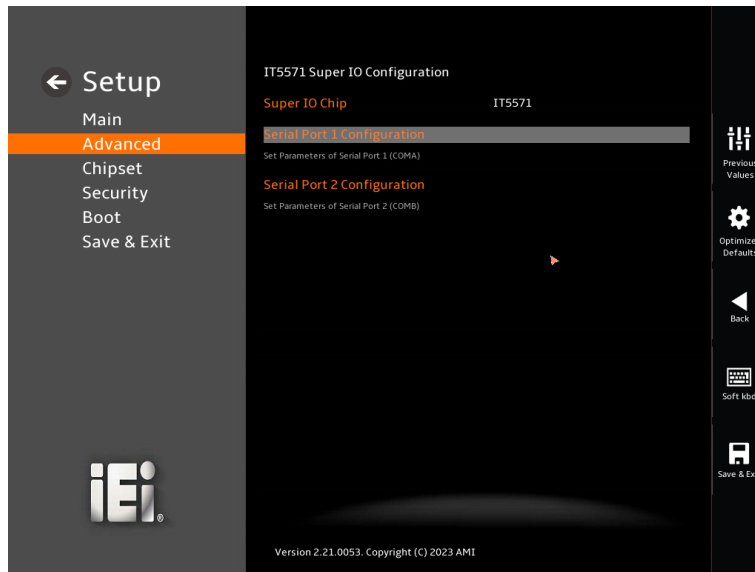

BIOS Menu 8: IT5571 Super IO Configuration

#### 5.3.3.1 Serial Port 1 Configuration

Use the **Serial Port 1 Configuration** menu (**BIOS Menu 9**) to configure the serial port n.

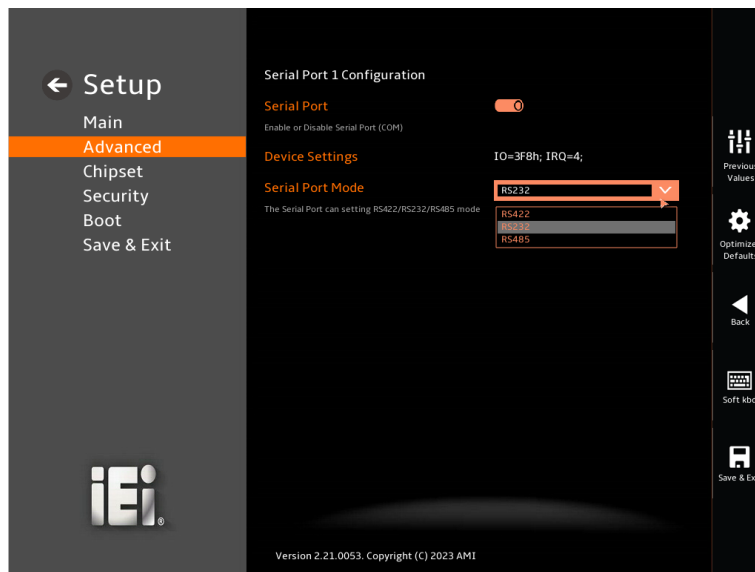

BIOS Menu 9: Serial Port 1 Configuration Menu

**DRPC-124-EHL****→ Serial Port [Enabled]**

Use the **Serial Port** option to enable or disable the serial port.

- Disabled**                      Disable the serial port
- Enabled**      **DEFAULT**      Enable the serial port

**→ Device Settings**

The Device Settings option shows the serial port IO port address and interrupt address.

- IO=3F8h;**                      Serial Port I/O port address is 3F8h and the interrupt  
**IRQ=4**                              address is IRQ4

**→ Serial Port Mode**

- RS232**                              The serial port mode is RS-232
- RS422**                              The serial port mode is RS-422
- RS485**                              The serial port mode is RS-485

### 5.3.3.2 Serial Port 2 Configuration

Use the **Serial Port 2 Configuration** menu (**BIOS Menu 10**) to configure the serial port n.

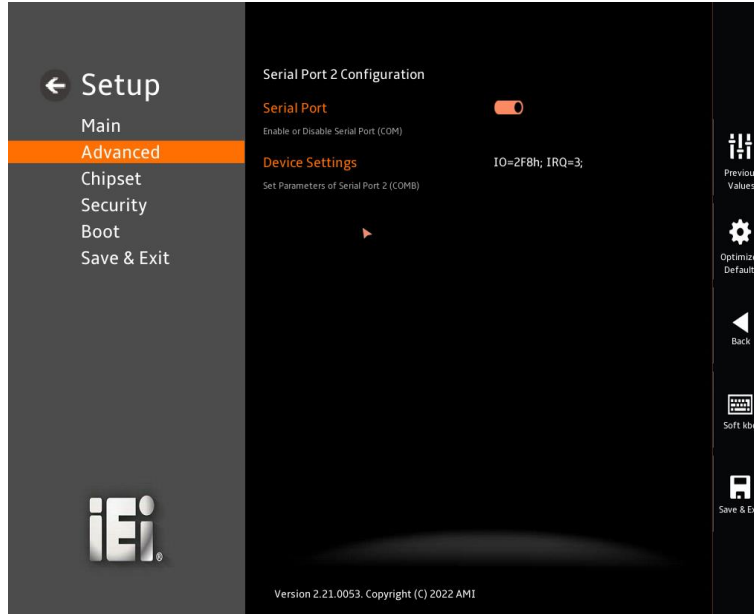

#### BIOS Menu 10: Serial Port 2 Configuration Menu

➔ **Serial Port [Enabled]**

Use the **Serial Port** option to enable or disable the serial port.

- ➔ **Disabled**                      Disable the serial port
- ➔ **Enabled      DEFAULT**      Enable the serial port

➔ **Device Settings**

The Device Settings option shows serial port IO port address and interrupt address.

- ➔ **IO=2F8h;**                      Serial Port I/O port address is 2F8h and the interrupt  
**IRQ=3**                              address is IRQ3

## DRPC-124-EHL

## 5.3.4 IT5571 H/W Monitor

The **IT5571 H/W Monitor** menu (**BIOS Menu 11**) contains the state of H/W real-time operating temperature and system voltages



## BIOS Menu 11: IT5571 H/W Monitor

## → PC Health Status

The following system parameters and values are shown. The system parameters that are monitored are:

- CPU Temperature
- System Temperature
- +V3P3DSW
- +V3P3S
- +V5S

## 5.3.5 Serial Port Console Redirection

The **Serial Port Console Redirection** menu (**BIOS Menu 12**) allows the console redirection options to be configured. Console Redirection allows users to maintain a system remotely by re-directing keyboard input and text output through the serial port.

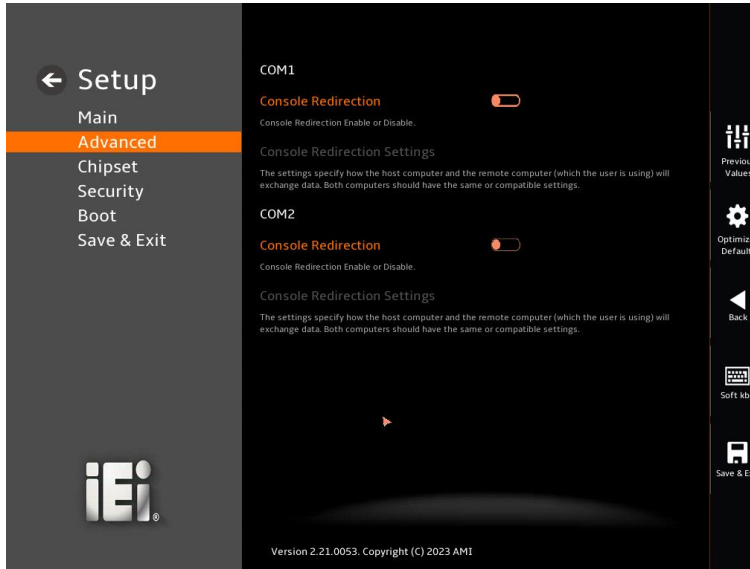

**BIOS Menu 12:Serial Port Console Redirection**

➔ **Console Redirection [Disabled]**

Use **Console Redirection** option to enable or disable the console redirection function.

- ➔ **Disabled**      **DEFAULT**      Disabled the console redirection function.
- ➔ **Enabled**                              Enabled the console redirection function.

The **Console Redirection Settings** submenu will be available when the **Console Redirection** option is enabled.

**5.3.5.1 Console Redirection Settings**

The following options are available in the **Console Redirection Settings** submenu (**BIOS Menu 13**) when the **COM Console Redirection** (for COM1 to COM2) option is enabled.



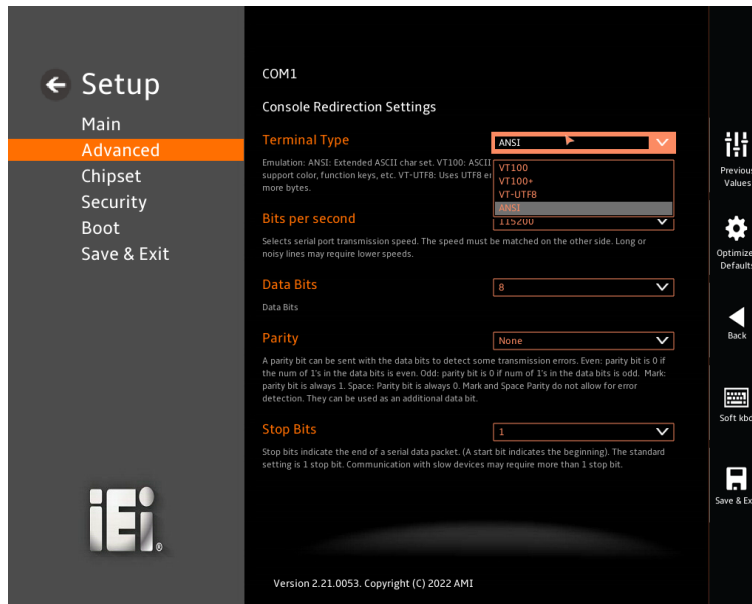

### BIOS Menu 13: COM Console Redirection Settings

#### ➔ Terminal Type [ANSI]

Use the **Terminal Type** option to specify the remote terminal type.

- ➔ **VT100**                      The target terminal type is VT100
- ➔ **VT100+**                    The target terminal type is VT100+
- ➔ **VT-UTF8**                    The target terminal type is VT-UTF8
- ➔ **ANSI**                      **DEFAULT**                    The target terminal type is ANSI

#### ➔ Bits per second [115200]

Use the **Bits per second** option to specify the serial port transmission speed. The speed must match on the other side. Long or noisy lines may require lower speeds.

- ➔ **9600**                        Sets the serial port transmission speed at 9600.
- ➔ **19200**                      Sets the serial port transmission speed at 19200.
- ➔ **38400**                      Sets the serial port transmission speed at 38400.
- ➔ **57600**                      Sets the serial port transmission speed at 57600.

→ 115200      DEFAULT      Sets the serial port transmission speed at 115200.

→ **Data Bits [8]**

Use the **Data Bits** option to specify the number of data bits.

→ 7      Sets the data bits at 7.

→ 8      DEFAULT      Sets the data bits at 8.

→ **Parity [None]**

Use the **Parity** option to specify the parity bit that can be sent with the data bits for detecting the transmission errors.

→ **None**      DEFAULT      No parity bit is sent with the data bits.

→ **Even**      The parity bit is 0 if the number of ones in the data bits is even.

→ **Odd**      The parity bit is 0 if the number of ones in the data bits is odd.

→ **Mark**      The parity bit is always 1. This option does not allow for error detection.

→ **Space**      The parity bit is always 0. This option does not allow for error detection.

→ **Stop Bits [1]**

Use the **Stop Bits** option to specify the number of stop bits used to indicate the end of a serial data packet. Communication with slow devices may require more than 1 stop bit.

→ 1      DEFAULT      Sets the number of stop bits at 1.

→ 2      Sets the number of stop bits at 2.

### 5.3.6 NVMe Configuration

Use the **NVMe Configuration** (BIOS Menu 14) menu to display the NVMe controller.

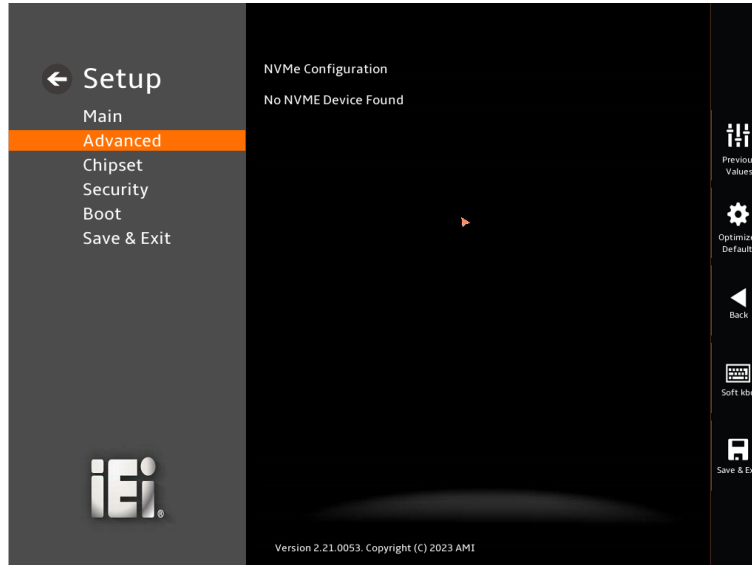

BIOS Menu 14: NVMe configuration

### 5.4 Chipset

Use the **Chipset** menu (**BIOS Menu 15**) to access the PCH IO and System Agent (SA) configuration menus.



#### **WARNING!**

Setting the wrong values for the Chipset BIOS selections in the Chipset BIOS menu may cause the system to malfunction.

---



**BIOS Menu 15: Chipset**

### 5.4.1 System Agent (SA) Configuration

Use the **System Agent (SA) Configuration** menu (**BIOS Menu 16**) to configure the System Agent (SA) parameters.

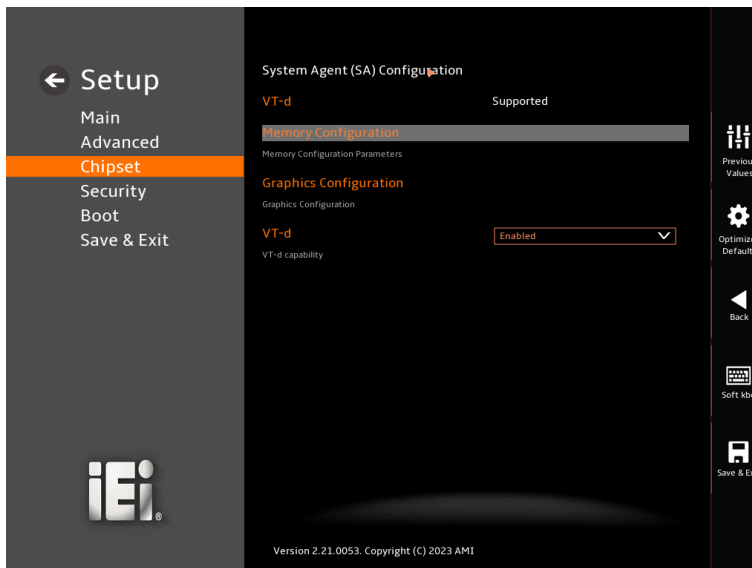

**BIOS Menu 16: System Agent (SA) Configuration**

➔ **VT-d [Enabled]**

Use the **VT-d** option to enable or disable the VT-d capability.

## DRPC-124-EHL

- ➔ **Disabled**                      Disable the VT-d capability
- ➔ **Enabled**            **DEFAULT**            Enable the VT-d capability

### 5.4.1.1 Memory Configuration

Use the **Memory Configuration** submenu (**BIOS Menu 17**) to view memory information.

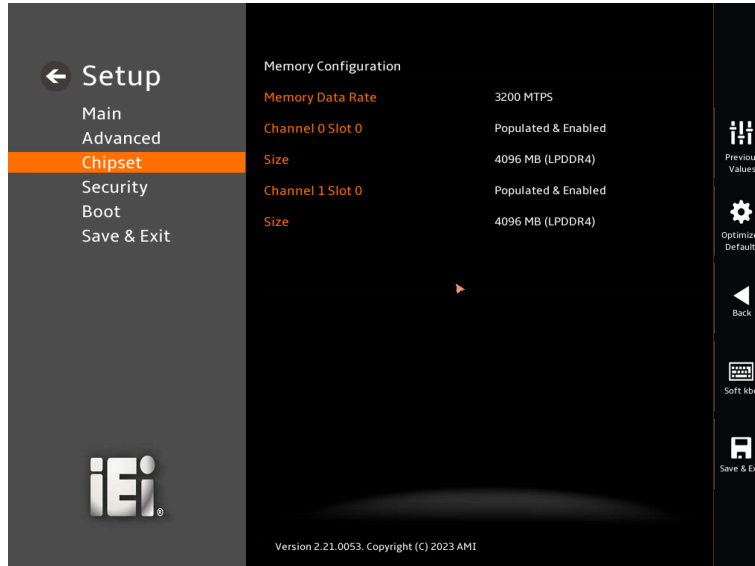

**BIOS Menu 17: Memory Configuration**

### 5.4.1.2 Graphics Configuration

Use the **Graphics Configuration (BIOS Menu 18)** menu to configure the video device connected to the system.



#### BIOS Menu 18: Graphics Configuration

##### → Primary Display [Auto]

Use the **Primary Display** option to select the primary graphics controller the system uses.

The following options are available:

- Auto                   **DEFAULT**
- IGFX
- PEG
- PCI
- Internal Graphics [Enabled]

Use the **Internal Graphics** option to configure whether to keep IGFX enabled. If user wants to support dual display by internal graphics and external graphics, this Internal Graphics option should be set to Enabled and the above Primary Display option should be set to IGFX.

- ➔ **Auto** Auto mode
- ➔ **Disabled** Disables IGFX.
- ➔ **Enabled** **DEFAULT** Enables IGFX.

➔ **DVMT Pre-Allocated [160M]**

Use the **DVMT Pre-Allocated** option to set the amount of system memory allocated to the integrated graphics processor when the system boots. The system memory allocated can then only be used as graphics memory, and is no longer available to applications or the operating system. Configuration options are listed below:

- 80M
- 160M **DEFAULT**

➔ **DVMT Total Gfx Mem [256M]**

Use the **DVMT Total Gfx Mem** option to select DVMT5.0 total graphic memory size used by the internal graphic device. The following options are available:

- 128M
- 256M
- MAX **DEFAULT**



### 5.4.2 PCH-IO Configuration

Use the **PCH-IO Configuration** menu (**BIOS Menu 19 & BIOS Menu 20**) to configure the PCH parameters.

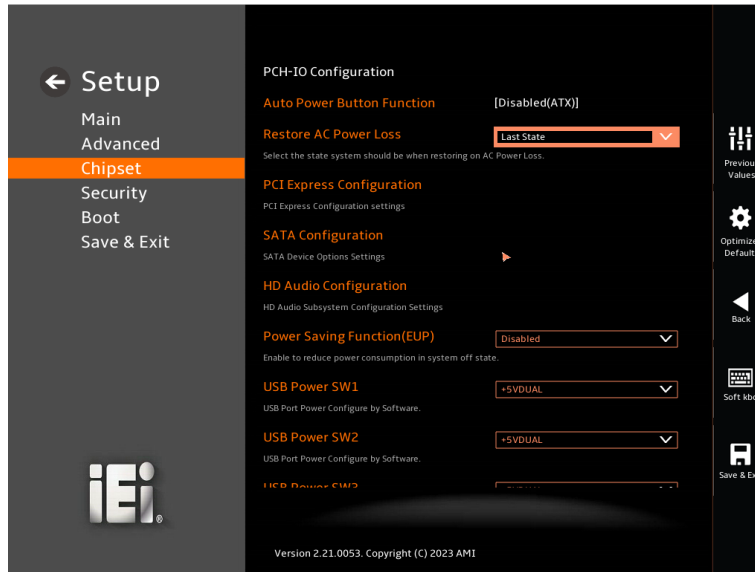

#### BIOS Menu 19: PCH-IO Configuration (1/2)

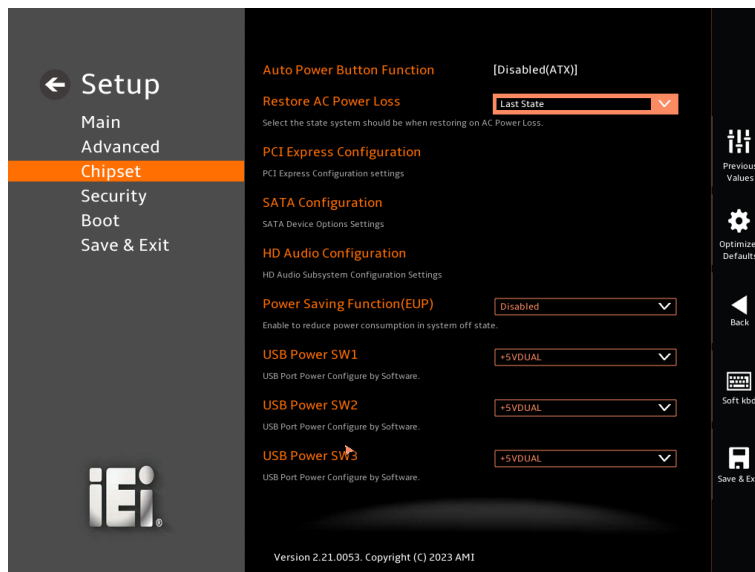

#### BIOS Menu 20: PCH-IO Configuration (2/2)

**→ Auto Power Button Function [Enabled (AT)]**

Use the **Auto Power Button Function** BIOS option to show the power mode state. Use the **J\_ATX\_AT1** to switch the AT/ATX power mode.

- **Enabled (AT)**                      The system power mode is AT.
- **Disabled (ATX)**                      The system power mode is ATX.

**→ Restore AC Power Loss [Last State]**

Use the **Restore AC Power Loss** BIOS option to specify what state the system returns to if there is a sudden loss of power to the system when the power mode is ATX.

- **Power Off**                      The system remains turned off
- **Power On**                      The system turns on
- **Last State**    **DEFAULT**      The system returns to its previous state. If it was on, it turns itself on. If it was off, it remains off.

**→ Power Saving Function (EUP) [Disabled]**

Use the **Power Saving Function (EUP)** BIOS option to enable or disable the power saving function.

- **Disabled**    **DEFAULT**      Power saving function is disabled.
- **Enabled**                      Power saving function is enabled. It will reduce power consumption when the system is off.

**→ USB Power SW1 [+5V DUAL]**

Use the **USB Power SW1** BIOS option to configure the USB power source for the corresponding USB connectors (Figure 5-4).

- **+5V DUAL**    **DEFAULT**      Sets the USB power source to +5V dual
- **+5V**                      Sets the USB power source to +5V

**DRPC-124-EHL****→ USB Power SW2 [+5V DUAL]**

Use the **USB Power SW2** BIOS option to configure the USB power source for the corresponding USB connectors (Figure 5-4).

→ **+5V DUAL**    **DEFAULT**    Sets the USB power source to +5V dual

→ **+5V**                                Sets the USB power source to +5V

**→ USB Power SW3 [+5V DUAL]**

Use the **USB Power SW3** BIOS option to configure the USB power source for the corresponding USB connectors (Figure 5-4).

→ **+5V DUAL**    **DEFAULT**    Sets the USB power source to +5V dual

→ **+5V**                                Sets the USB power source to +5V

<b>BIOS Options</b>	<b>Configured USB Ports</b>
USB Power SW1	USB_CN1 external USB 2.0 ports
USB Power SW2	USB_CN2 external USB 3.2 Gen2 ports
USB Power SW3	USB_CN3 internal pin header

**Figure 5-4: BIOS Options and Configured USB Ports**

### 5.4.2.1 PCI Express Configuration

Use the **PCI Express Configuration** submenu (**BIOS Menu 21**) to configure the PCI Express slots.

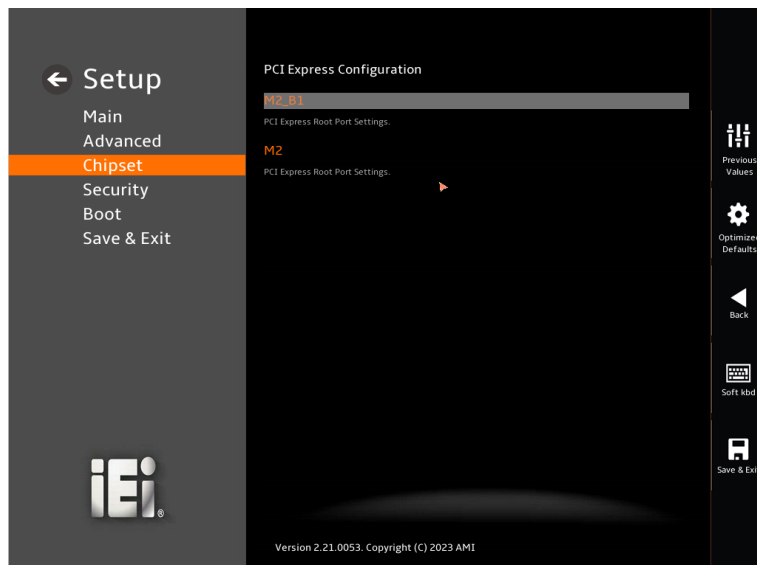

**BIOS Menu 21: PCI Express Configuration**

### 5.4.2.1.1 PCI Express Root Port Setting

Use the **M2\_B1** and **M.2** submenu (**BIOS Menu 22**) to configure the PCI Root Port Setting.



### BIOS Menu 22: PCIe Slot Configuration Submenu

#### → PCIe Speed [Auto]

Use the **PCIe Speed** option to specify the PCI Express port speed. Configuration options are listed below.

- |   |             |                |                               |
|---|-------------|----------------|-------------------------------|
| → | <b>Auto</b> | <b>DEFAULT</b> | Auto mode.                    |
| → | <b>Gen1</b> |                | Configure PCIe Speed to Gen1. |
| → | <b>Gen2</b> |                | Configure PCIe Speed to Gen2. |
| → | <b>Gen3</b> |                | Configure PCIe Speed to Gen3. |

→ **Detect Non-Compliance Device [Disabled]**

Use the **Detect Non-Compliance Device** option to configure whether to detect if a non-compliance PCI Express device is connected to the PCI Express port.

- **Disabled**                      **DEFAULT**      Do not detect if a non-compliance PCI Express device is connected to the PCI Express port.
- **Enabled**                              Detect if a non-compliance PCI Express device is connected to the PCI Express port.

### 5.4.2.2 SATA Configuration

Use the **SATA Configuration** menu (**BIOS Menu 23**) to change and/or set the configuration of the SATA devices installed in the system.

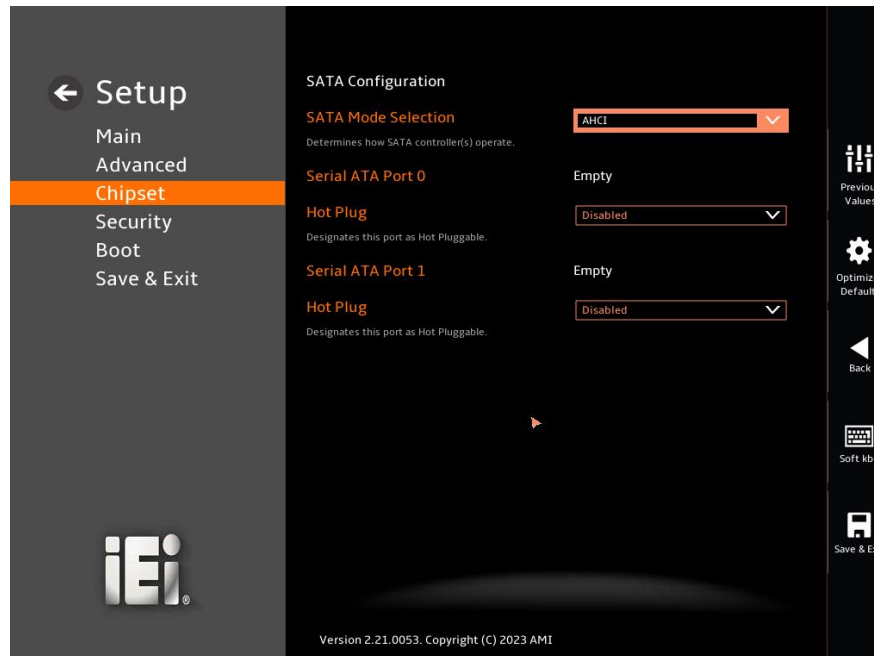

#### BIOS Menu 23: SATA Configuration

##### → SATA Mode Selection [AHCI]

Use the **SATA Mode Selection** option to determine how the SATA devices operate.

→ **AHCI**      **DEFAULT**      Configures SATA devices as AHCI device.

##### → Hot Plug [Disabled]

Use the **Hot Plug** option to designate the correspondent port as hot-pluggable.

→ **Disabled**      **DEFAULT**      Disables the hot-pluggable function of the SATA port.

→ **Enabled**      Designate the SATA port as hot-pluggable

### 5.4.2.3 HD Audio Configuration

Use the **HD Audio Configuration** menu (**BIOS Menu 24**) to configure the PCH Azalia settings.

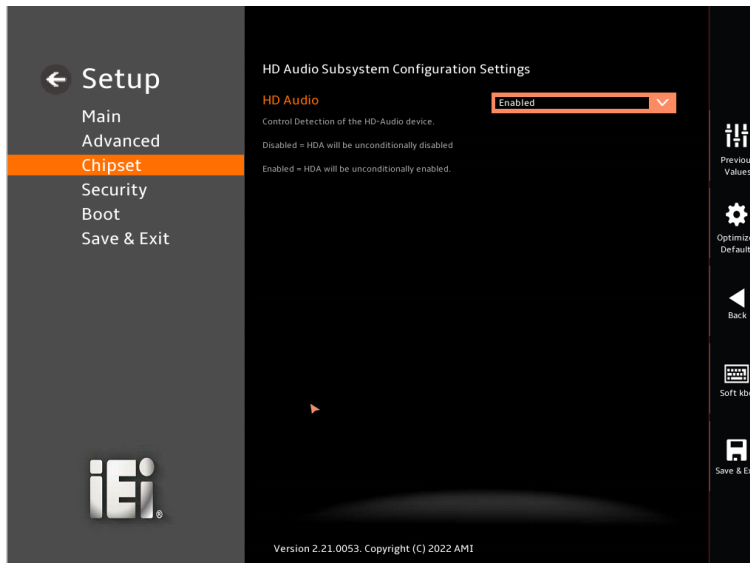

#### BIOS Menu 24: HD Audio Configuration

##### ➔ HD Audio [Enabled]

Use the **HD Audio** option to enable or disable the High Definition Audio controller.

- ➔ **Disabled**                      The onboard High Definition Audio controller is disabled.
- ➔ **Enabled**    **DEFAULT**      The onboard High Definition Audio controller is enabled.



## 5.5 Security

Use the **Security** menu (**BIOS Menu 25**) to set system and user passwords.



### BIOS Menu 25: Security

#### → Administrator Password

Use the **Administrator Password** to set or change a administrator password.

#### → User Password

Use the **User Password** to set or change a user password.

## 5.6 Boot

Use the **Boot** menu (**BIOS Menu 26**) to configure system boot options.

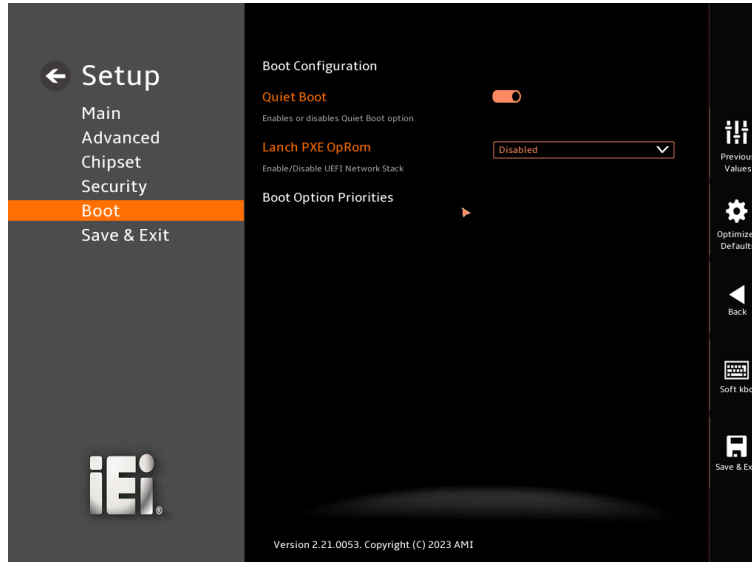

### BIOS Menu 26: Boot

#### 5.6.1 Boot Configuration

##### → Quiet Boot [Enabled]

Use the **Quiet Boot** BIOS option to select the screen display when the system boots.

- **Disabled**                      Normal POST messages displayed
- **Enabled**                      **DEFAULT**                      OEM Logo displayed instead of POST messages

##### → Launch PXE OpROM [Disabled]

Use the **Launch PXE OpROM** option to enable or disable boot option for legacy network devices.

- **Disabled**                      **DEFAULT**                      Ignore all PXE Option ROMs
- **Enabled**                                      Load PXE Option ROMs.

**DRPC-124-EHL****5.6.2 Boot Option Priorities**

Use the Boot Option # N to choose the system boots from the peripherals you selected  
The following Boot Options are listed as an example.

**→ Boot Option #1**

Sets the system boot order **ADATA SP580** as the first priority.

**→ Windows Boot Manager (P1: ADATA SSD SP580 240GB)**

**→ Disabled**

**→ Boot Option #2**

Sets the system boot order **USB Partition 1** as the second priority.

**→ UEFI: USB, Partition 1**

**→ Disabled**

## 5.7 Save & Exit

Use the **Save & Exit** menu (**BIOS Menu 27**) to load default BIOS values, optimal failsafe values and to save configuration changes.

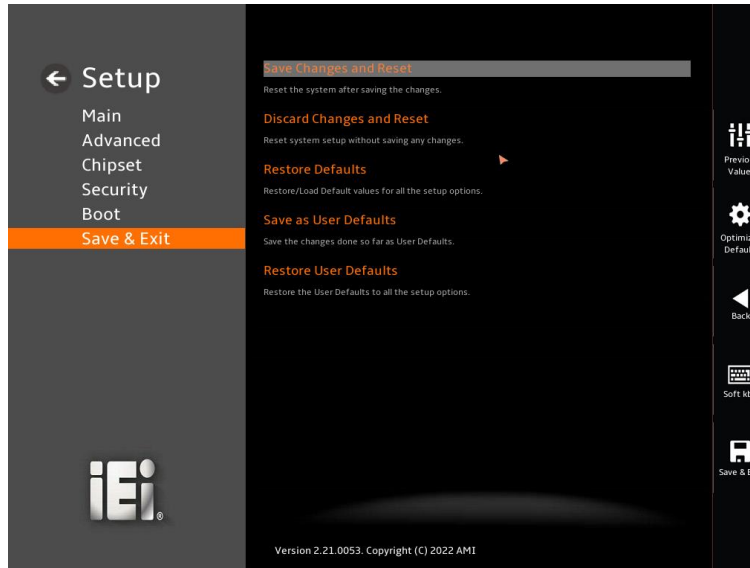

### BIOS Menu 27: Save & Exit

#### → Save Changes and Reset

Use the Save Changes and Reset option to save the changes made to the BIOS options and reset the system.

#### → Discard Changes and Reset

Use the **Discard Changes and Reset** option to exit the system without saving the changes made to the BIOS configuration setup program.

#### → Restore Defaults

Use the **Restore Defaults** option to load the optimal default values for each of the parameters on the Setup menus. **F3 key can be used for this operation.**

#### → Save as User Defaults

Use the **Save as User Defaults** option to save the changes done so far as user defaults.

## DRPC-124-EHL

### → Restore User Defaults

Use the **Restore User Defaults** option to restore the user defaults to all the setup options.

Appendix

**A**

# Regulatory Compliance

---

**DECLARATION OF CONFORMITY**

This equipment has been tested and found to comply with specifications for CE marking. If the user modifies and/or installs other devices in the equipment, the CE conformity declaration may no longer apply.

**FCC WARNING**

This equipment complies with Part 15 of the FCC Rules. Operation is subject to the following two conditions:

- This device may not cause harmful interference, and
- This device must accept any interference received, including interference that may cause undesired operation.

This equipment has been tested and found to comply with the limits for a Class A digital device, pursuant to part 15 of the FCC Rules. These limits are designed to provide reasonable protection against harmful interference when the equipment is operated in a commercial environment. This equipment generates, uses, and can radiate radio frequency energy and, if not installed and used in accordance with the instruction manual, may cause harmful interference to radio communications. Operation of this equipment in a residential area is likely to cause harmful interference in which case the user will be required to correct the interference at his own expense.

Appendix

**B**

# Product Disposal

---



**CAUTION:**

Risk of explosion if battery is replaced by an incorrect type. Only certified engineers should replace the on-board battery.

Dispose of used batteries according to instructions and local regulations.

---

Outside the European Union—If you wish to dispose of used electrical and electronic products outside the European Union, please contact your local authority so as to comply with the correct disposal method.

Within the European Union—The device that produces less waste and is easier to recycle is classified as electronic device in terms of the European Directive 2012/19/EU (WEEE), and must not be disposed of as domestic garbage.

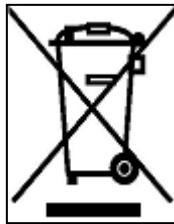

EU-wide legislation, as implemented in each Member State, requires that waste electrical and electronic products carrying the mark (left) must be disposed of separately from normal household waste. This includes monitors and electrical accessories, such as signal cables or power cords.

When you need to dispose of your device, please follow the guidance of your local authority, or ask the shop where you purchased the product. The mark on electrical and electronic products only applies to the current European Union Member States.

Please follow the national guidelines for electrical and electronic product disposal.

Appendix

C

# Error Beep Code

---

## DRPC-124-EHL

**C.1 PEI Beep Codes**

Number of Beeps	Description
1	Memory not Installed
1	Memory was installed twice (InstallPeiMemory routine in PEI Core called twice)
2	Recovery started
3	DXEIPL was not found
3	DXE Core Firmware Volume was not found
4	Recovery failed
4	S3 Resume failed
7	Reset PPI is not available

**C.2 DXE Beep Codes**

Number of Beeps	Description
1	Invalid password
4	Some of the Architectural Protocols are not available
5	No Console Output Devices are found
5	No Console Input Devices are found
6	Flash update is failed
7	Reset protocol is not available
8	Platform PCI resource requirements cannot be met

**NOTE:**

If you have any question, please contact IEI for further assistance.

Appendix

**D**

# Hazardous Materials Disclosure

---

**DRPC-124-EHL**

**D.1 RoHS II Directive (2015/863/EU)**

The details provided in this appendix are to ensure that the product is compliant with the RoHS II Directive (2015/863/EU). The table below acknowledges the presences of small quantities of certain substances in the product, and is applicable to RoHS II Directive (2015/863/EU).

Please refer to the following table.

Part Name	Toxic or Hazardous Substances and Elements									
	Lead (Pb)	Mercury (Hg)	Cadmium (Cd)	Hexavalent Chromium (CR(VI))	Polybrominated Biphenyls (PBBs)	Polybrominated Diphenyl Ethers (PBDEs)	Bis(2-ethylhexyl) phthalate (DEHP)	Butyl benzyl phthalate (BBP)	Dibutyl phthalate (DBP)	Diisobutyl phthalate (DIBP)
Housing	O	O	O	O	O	O	O	O	O	O
Printed Circuit Board	O	O	O	O	O	O	O	O	O	O
Metal Fasteners	O	O	O	O	O	O	O	O	O	O
Cable Assembly	O	O	O	O	O	O	O	O	O	O
Fan Assembly	O	O	O	O	O	O	O	O	O	O
Power Supply Assemblies	O	O	O	O	O	O	O	O	O	O
Battery	O	O	O	O	O	O	O	O	O	O
<p>O: This toxic or hazardous substance is contained in all of the homogeneous materials for the part is below the limit requirement in Directive (EU) 2015/863.</p> <p>X: This toxic or hazardous substance is contained in at least one of the homogeneous materials for this part is above the limit requirement in Directive (EU) 2015/863.</p>										

## D.2 China RoHS

此附件旨在确保本产品符合中国 RoHS 标准。以下表格标示此产品中某有毒物质的含量符合中国 RoHS 标准规定的限量要求。

本产品上会附有“环境友好使用期限”的标签，此期限是估算这些物质“不会有泄漏或突变”的年限。本产品可能包含有较短的环境友好使用期限的可替换元件，像是电池或灯管，这些元件将会单独标示出来。

部件名称	有毒有害物质或元素					
	铅 (Pb)	汞 (Hg)	镉 (Cd)	六价铬 (CR(VI))	多溴联苯 (PBB)	多溴二苯醚 (PBDE)
壳体	○	○	○	○	○	○
印刷电路板	○	○	○	○	○	○
金属螺帽	○	○	○	○	○	○
电缆组装	○	○	○	○	○	○
风扇组装	○	○	○	○	○	○
电力供应组装	○	○	○	○	○	○
电池	○	○	○	○	○	○

○: 表示该有毒有害物质在该部件所有物质材料中的含量均在 SJ/T11364-2014 與 GB/T26572-2011 标准规定的限量要求以下。X: 表示该有毒有害物质至少在该部件的某一均质材料中的含量超出 SJ/T11364-2014 與 GB/T26572-2011 标准规定的限量要求。